

Z890 Sani-Flo 6" Stainless Steel Drain System (4" Throat)

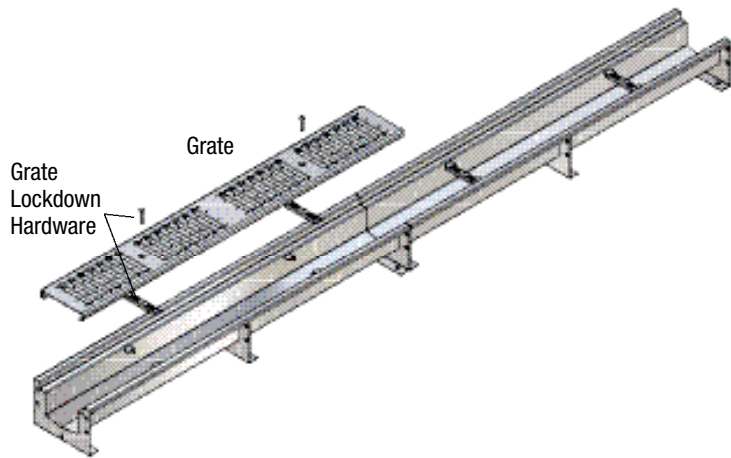

Closed End Cap (E1)
Z890 supplied with outlet attached.

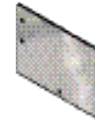

End Outlet (2", 3", 4", 6" NH)
Z890 supplied with outlet attached.



Bottom Outlet (2", 3", 4", 6" NH)
Z890 supplied with outlet attached.



Z890 Applications

- Food Processing
- Breweries
- Dairies
- Chemical Plants
- Showers/Restrooms
- Pharmaceuticals

Features and Benefits

- 5' Pre-engineered Modular Sections
- 1.04% Built-in Slope
- Smooth Seamless Construction
- Variety of Gratings – See pages 24-25.
- Custom Fabrications
- Optional – Type 316 Stainless Steel Available
- Optional – Clamping Collar and Pan (-KC)

Installation Specification

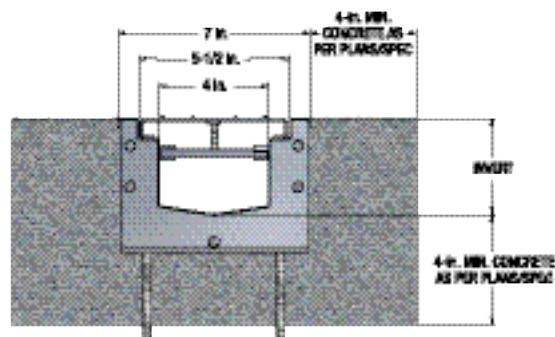

4" Throat / 7" Overall Width
Consult Plans and Specifications

Z890 Dimensional Data

Trench Number	Shallow Invert		Deep Invert		Max. Flow Rate			Approx. Weight (Less Grate)	
	Inches	mm	Inches	mm	GPM	LPS	CFS	Lbs.	Kg
89001	3.50	89	4.13	105	97	6	0.216	20	9.0
89002	4.13	105	4.75	121	124	8	0.276	21	9.5
89002N	4.75	121	4.75	121	–	–	–	22	10.0
89003	4.75	121	5.38	137	151	10	0.336	23	10.4
89004	5.38	137	6.00	152	179	11	0.399	24	10.9
89004N	6.00	152	6.00	152	–	–	–	25	11.3
89005	6.00	152	6.63	168	207	13	0.461	26	11.8
89006	6.63	168	7.25	184	235	15	0.524	27	12.2
89006N	7.25	184	7.25	184	–	–	–	28	12.7
89007	7.25	184	7.88	200	263	17	0.586	29	13.1
89008	7.88	200	8.50	216	292	18	0.651	30	13.6
89008N	8.50	216	8.50	216	–	–	–	31	14.0
89009	8.50	216	9.13	232	321	20	0.715	32	14.5
89010	9.13	232	9.75	248	349	22	0.778	34	15.4
89010N	9.75	248	9.75	248	–	–	–	35	15.9
89011	9.75	248	10.38	264	378	24	0.842	35	15.9
89012	10.38	264	11.00	279	407	26	0.907	37	16.8
89012N	11.00	279	11.00	279	–	–	–	38	17.2
89013	11.00	279	11.63	295	436	28	0.971	39	17.7
89014	11.63	295	12.25	311	465	29	1.036	40	18.1
89014N	12.25	311	12.25	311	–	–	–	41	18.6
89015	12.25	311	12.88	327	494	31	1.101	42	19.0
89016	12.88	327	13.50	343	523	33	1.165	43	19.5
89016N	13.50	343	13.50	343	–	–	–	44	20.0
89017	13.50	343	14.13	359	552	35	1.230	45	20.4
89018	14.13	359	14.75	375	581	37	1.295	46	20.8
89018N	14.75	375	14.75	375	–	–	–	47	21.3
89019	14.75	375	15.38	391	610	39	1.359	48	21.8
89020	15.38	391	16.00	406	639	40	1.424	49	22.2

Engineering Specification Channels shall be 5' long, 6" wide, and have a 4" wide throat. Modular channel sections shall be made of 16-gauge 304 stainless steel and shall be provided with a gasket for flanged connections. Channel shall be provided either flat (neutral) or with a 1.04% pre-slope. Channels shall be available with inverts ranging from 3.5" to 16.00". Choice of class A, B, C, D, E, and F grates shall be available with H-20 and/or FAA load ratings and/or ADA compliance with mechanical lockdown devices (refer to pages 24 and 25). End caps and catch basins shall be available to complement the channels and grates. End outlets, bottom outlets, and side outlets shall be available in 2", 3", 4", and 6" diameters. Trench drain shall be Flo-Thru model Z890. For downloadable CSI format specification, visit www.zurn.com.

Z895 Sani-Flo 12" Stainless Steel Drain System (9.25" Throat)

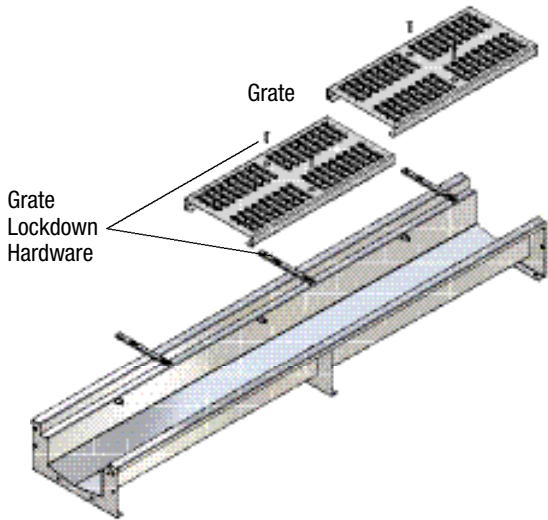

Closed End Cap (E1)
Z895 supplied with outlet attached.

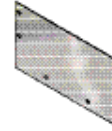

End Outlet (4", 6", 8" NH)
Z895 supplied with outlet attached.

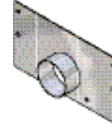

Bottom Outlet (4", 6", 8" NH)
Z895 supplied with outlet attached.



Z895 Applications

- Food Processing Breweries
- Dairies Chemical Plants
- Showers/Restrooms Pharmaceuticals

Features and Benefits

- 5' Pre-engineered Modular Sections
- 1.04% Built-in Slope
- Smooth Seamless Construction
- Variety of Gratings – See page 26.
- Custom Fabrications
- Optional – Type 316 Stainless Steel Available
- Optional – Clamping Collar and Pan (-KC)

Installation Specification

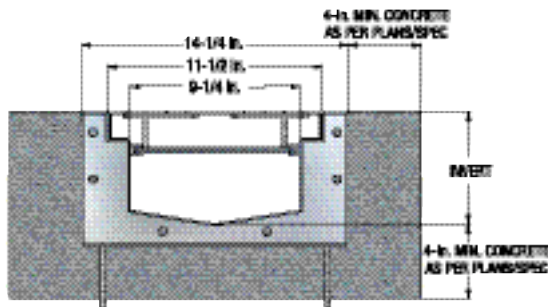

9-1/8" Throat / 14-5/16" Overall Width
Consult Plans and Specifications

Z895 Dimensional Data

Trench Number	Shallow Invert		Deep Invert		Max. Flow Rate			Approx. Weight (Less Grate)	
	Inches	mm	Inches	mm	GPM	LPS	CFS	Lbs.	Kg
89501	6.00	152	6.63	168	548	35	1.221	70	31.7
89502	6.63	168	7.25	184	652	41	1.453	73	33.1
89502N	7.25	184	7.25	184	–	–	–	74	33.5
89503	7.25	184	7.88	200	759	48	1.691	76	34.5
89504	7.88	200	8.50	216	868	55	1.934	80	36.3
89504N	8.50	216	8.50	216	–	–	–	81	36.7
89505	8.50	216	9.13	232	978	62	2.179	83	37.6
89506	9.13	232	9.75	248	1090	69	2.429	86	39.0
89506N	9.75	248	9.75	248	–	–	–	87	39.4
89507	9.75	248	10.38	264	1203	76	2.680	90	40.8
89508	10.38	264	11.00	279	1316	83	2.932	93	42.2
89508N	11.00	279	11.00	279	–	–	–	94	42.6
89509	11.00	279	11.63	295	1431	91	3.189	96	43.5
89510	11.63	295	12.25	311	1546	98	3.445	99	44.9
89511	12.25	311	12.88	327	1662	105	3.703	103	46.7
89512	12.88	327	13.50	343	1779	113	3.964	106	48.0
89512N	13.50	343	13.50	343	–	–	–	107	48.5
89513	13.50	343	14.13	359	1896	120	4.225	109	49.4
89514	14.13	359	14.75	375	2013	127	4.485	113	51.2
89514N	14.75	375	14.75	375	–	–	–	114	51.7
89515	14.75	375	15.38	391	2131	135	4.748	116	52.6
89516	15.38	391	16.00	406	2249	142	5.011	119	54.0
89516N	16.00	406	16.00	406	–	–	–	120	54.4
89517	16.00	406	16.63	422	2368	150	5.276	122	55.3
89518	16.63	422	17.25	438	2487	157	5.541	126	57.1
89518N	17.25	438	17.25	438	–	–	–	127	57.6
89519	17.25	438	17.88	454	2606	165	5.807	129	58.5
89520	17.88	454	18.50	470	2752	174	6.132	132	59.9

Engineering Specification Channels shall be 5' long, 12" wide, and have a 9-1/8" wide throat. Modular channel sections shall be made of 16-gauge 304 stainless steel. Channel shall be provided with no slope (neutral) or with a 1.04% built-in slope. Channels shall be available with inverts ranging from 6.00" to 18.50". Choice of class A, B, C, D, E, and F grates shall be available with H-20 and/or FAA load ratings and/or ADA compliance with mechanical lockdown devices (refer to page 26). End caps and catch basins shall be available to complement the channels and grates. End outlets, bottom outlets, and side outlets shall be available in 4", 6", and 8" diameters. Trench drain shall be Flo-Thru model Z895. For downloadable CSI format specification, visit www.zurn.com.

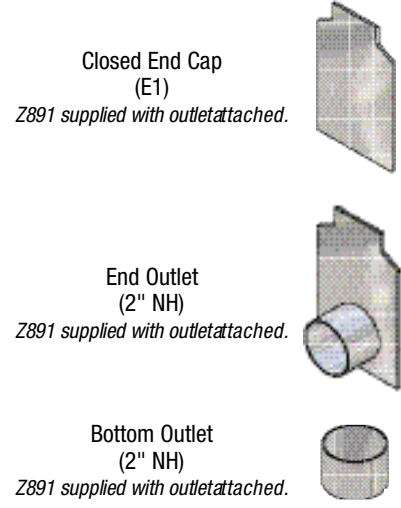
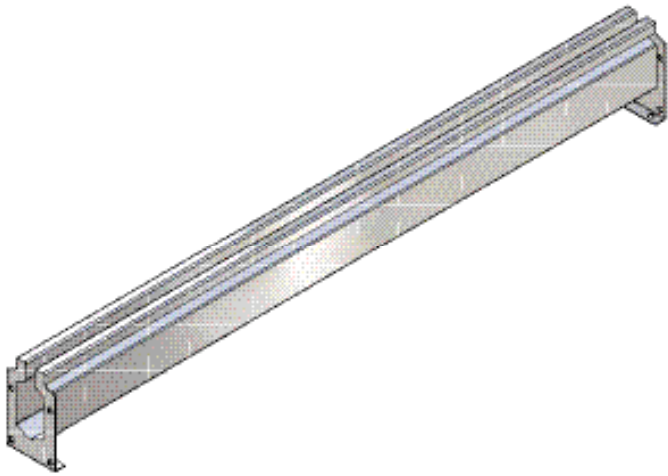

Z891 Applications

- Food Processing
- Dairies
- Showers/Restrooms
- Breweries
- Chemical Plants
- Pharmaceuticals

Installation Specification

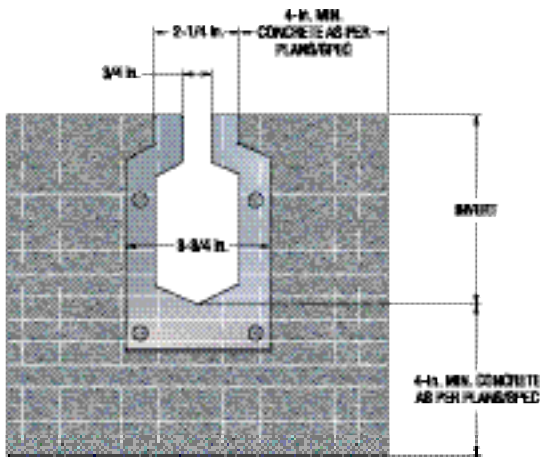

Consult Plans and Specifications

Features and Benefits

- 5' Pre-engineered Modular Sections – Allows quick and easy assembly, straighter installation.
- 1.04% Built-In Slope (1/8" per Foot) – Able to handle greater flows, uniform slope.
- Smooth, Seamless Construction – Provides clean, sanitary installation.
- Durable and Lightweight – Strong corrosion-resistant material.
- Bolted, Gasketed Feature – Keeps trench system straight and liquid tight.
- Optional – Type 316 Stainless Steel Available
- Optional – Anchoring leg

Z891 Dimensional Data

Trench Number	Shallow Invert		Deep Invert		Max. Flow Rate			Approx. Weight (Less Grate)	
	Inches	mm	Inches	mm	GPM	LPS	LPM	Lbs.	Kg
89101	4.00	102	4.63	118	51	3	194	15	6.8
89102	4.63	118	5.25	133	67	4	255	16	7.3
89103	5.25	133	5.88	149	84	5	316	17	7.7
89104	5.88	149	6.50	165	100	6	378	18	8.2
89105	6.50	165	7.13	181	117	7	441	19	8.6
89106	7.13	181	7.75	197	135	8	504	20	9.1
89107	7.75	197	8.38	213	150	9	568	21	9.6
89108	8.38	213	9.00	229	167	11	632	22	10.0
89109	9.00	229	9.63	245	184	12	696	23	10.5
89110	9.63	245	10.25	260	201	13	760	24	10.9

Engineering Specification Channels shall be 5' long, 3/4" wide slot, and have a 2-1/4" wide throat. Modular channel sections shall be made of 16-gauge type 304 stainless steel. Channel shall be provided with no slope (neutral) or with a 1.04% built-in slope. Channels shall be available with inverts ranging from 4" to 16.5". End caps and catch basins shall be available to complement the channels. Trench drain shall be Flo-Thru model Z891. For downloadable CSI format specification, visit www.zurn.com.

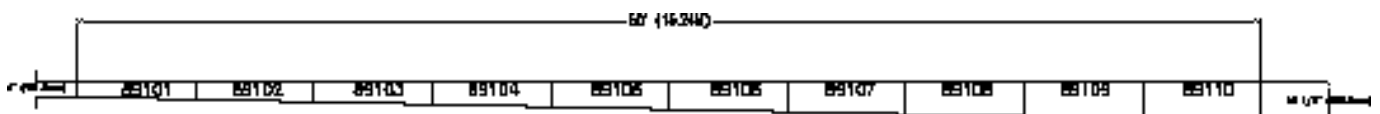

Z897 Applications

- Food Processing
- Dairies
- Showers/Restrooms
- Breweries
- Chemical Plants
- Pharmaceuticals

Installation Specification

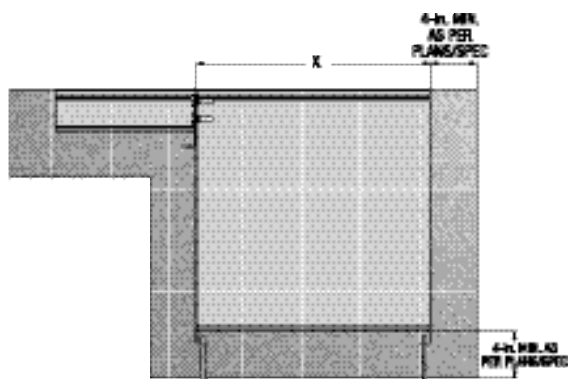

Consult Plans and Specifications

Features and Benefits

- **6" x 20" Catch Basin** – The 6" x 20" basin is meant to be used as an in-line sump for applications where, from the top surface, the visual appearance is of continuous 6" wide Z890 trenching. These catch basins with bolted flange connection come complete with flange gasket and assembly hardware for fast, easy installation. Outlets are fabricated at the factory based upon the specified location.
- **12" x 24" and 24" x 24" Catch Basins** – The larger catch basins, 12" x 24" x 24" and 24" x 24" x 24", provide greater sump capacities for larger trench runs and can be used with Z890 and Z895 trenches. These basins share a bolted flanged connection and come complete with flanged gasket and assembly hardware for fast, easy installation. Outlets are fabricated at the factory based upon the specified location.
- **Optional** – Type 316 Stainless Steel Available

Z897 Dimensional Data

Nominal Size	Width		Overall Dimensions Length		Depth		Approx. Weight (Less Grate)	
	Inches	mm	Inches	mm	Inches	mm	Lbs.	Kg
6 x 20	7	178	20	508	20-3/4	527	49	22
12 x 24	14-5/16	363	24-1/8	612	24-3/4	629	67	30
24 x 24	26-5/16	685	25-9/16	647	24-3/4	629	88	40

Z897 System Highlights

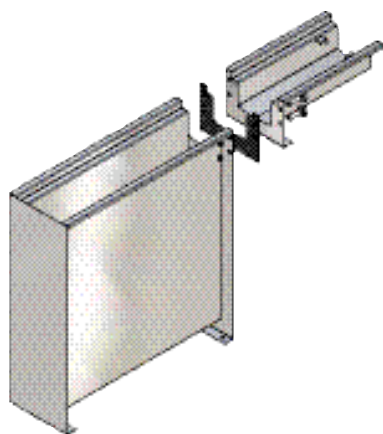

6" x 20" Catch Basin with Z890 Connecting Trench

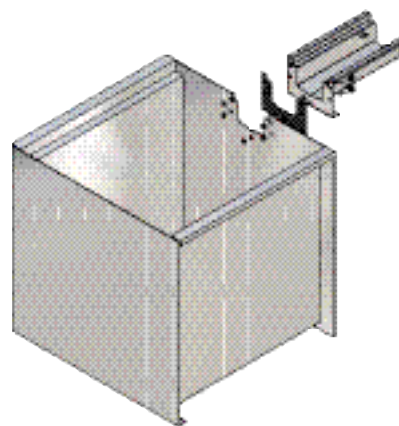

24" x 24" Catch Basin with Z890 Connecting Trench

Engineering Specification Catch Basins shall be 6" wide x 20" long x 20" deep, 12" wide x 24" long x 24" deep, or 24" wide x 24" long x 24" deep and shall be made of #16- or #12-gauge 304 stainless steel. Choice of class A, B, C, D, E, and F grates shall be available with H-20, FAA, and/or ADA compliance with mechanical lockdown devices. Outlets in 2", 3", 4", 6", and 8" diameters shall be available. Catch Basin shall be Flo-Thru model Z897. For downloadable CSI format specification, visit www.zurn.com.

Z706 6" Frame and Grate System

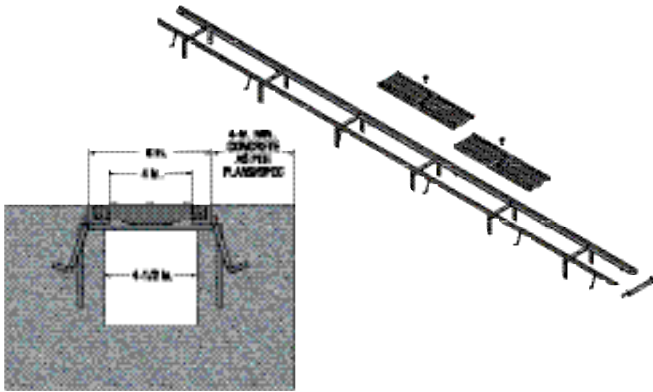

Engineering Specification Z706 6" Wide Frame and Grate System. 1" x 1" x 1/4" angle, 10' long, carbon steel frame assembly. 1/4" x 3" studs and combination anchor tabs/leveling devices at appropriate locations for embedding into surrounding concrete. Complete with Class C ductile iron slotted grates (-DGC).

Z717 17" Frame and Grate System

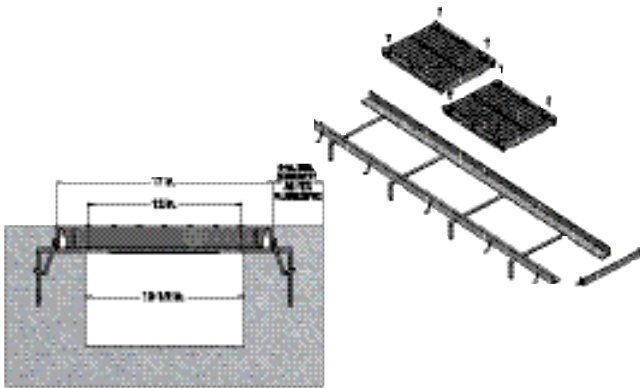

Engineering Specification Z717 17" Wide Frame and Grate System. 2" x 2-1/2" x 1/4" angle, 80" long, carbon steel frame assembly. 1/4" x 3" studs and combination anchor tabs/leveling devices at appropriate locations for embedding into surrounding concrete. Complete with Class C ductile iron slotted grates (-DGC).

Z726 26" Frame and Grate System

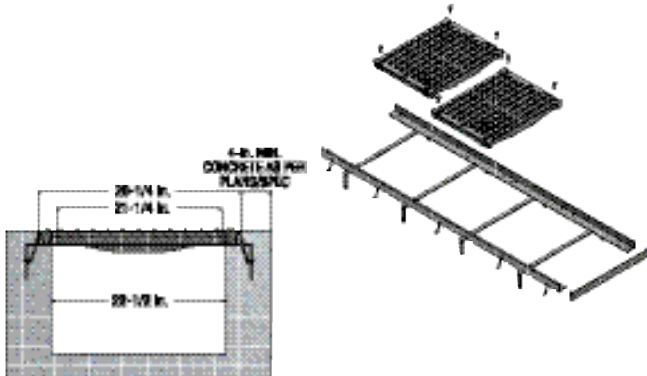

Engineering Specification Z726 26" Wide Frame and Grate System. 2" x 2-1/2" x 1/4" angle, 80" long, carbon steel frame assembly. 1/4" x 3" studs and combination anchor tabs/leveling devices at appropriate locations for embedding into surrounding concrete. Complete with Class C ductile iron slotted grates (-DGC).

Z712 12" Frame and Grate System

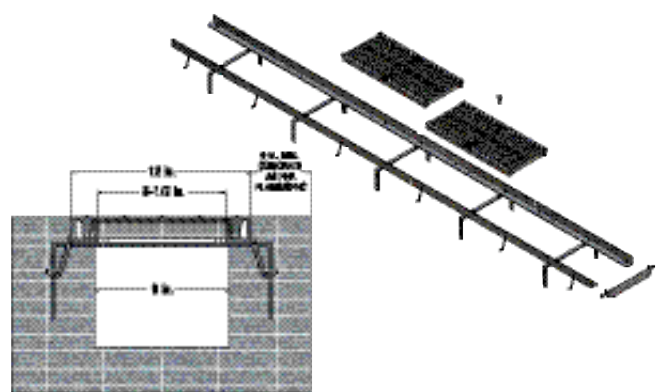

Engineering Specification Z712 12" Wide Frame and Grate System. 1-3/4" x 1-3/4" x 1/4" angle, 10' long, carbon steel frame assembly. 1/4" x 3" studs and combination anchor tabs/leveling devices at appropriate locations for embedding into surrounding concrete. Complete with Class C ductile iron slotted grates (-DGC).

Z723 23" Frame and Grate System

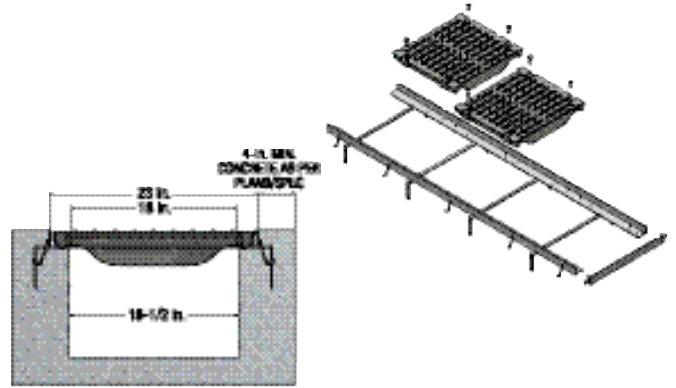

Engineering Specification Z723 23" Wide Frame and Grate System. 2" x 2-1/2" x 1/4" angle, 80" long, carbon steel frame assembly. 1/4" x 3" studs and combination anchor tabs/leveling devices at appropriate locations for embedding into surrounding concrete. Complete with Class C ductile iron slotted grates (-DGC).

6" System Grates

Suffix	Description	Material	Weight (lbs./ft.)	Length	Open Area (sq. in. per ft.)	Slot Width/ Hole Size	DIN	ANSI	ADA	H-20	FAA
AWG	Aluminum Wire Grate	Aluminum	0.60	40"	78.00	0.250	A	Light Duty	Yes	No	No
BCD	Circular Decorative	Bronze	5.60	20"	6.80	0.250	A	Light Duty	Yes	No	No
BDD	Diagonal Decorative	Bronze	5.30	20"	15.20	0.250	A	Light Duty	Yes	No	No
BZ	Bronze Decorative	Bronze	5.39	20"	17.57	0.250	A	Light Duty	Yes	No	No
DDD	Diagonal Decorative	Ductile Iron	4.60	20"	15.20	0.250	A	Light Duty	Yes	No	No
DWV	Decorative Wave Grate	Ductile Iron	4.20	20"	36.85	0.880	A	Light Duty	No	No	No
FG	Fabricated Slotted	Galvanized Steel	1.68	40"	13.68	0.375	A	Light Duty	No	No	No
FS	Fabricated Slotted	Stainless Steel	1.68	40"	13.68	0.375	A	Light Duty	No	No	No
GG	Slotted Grate	Fiberglass	0.98	40"	41.63	0.375	A	Light Duty	No	No	No
HPB	Heel-Proof Slotted	Bronze	5.90	20"	15.50	0.250	A	Light Duty	Yes	No	No
HPP	Heel-Proof Slotted	HDPE	0.90	20"	14.50	0.250	A	Light Duty	Yes	No	No
HPS	Heel-Proof Slotted	Stainless Steel	5.70	20"	15.50	0.250	A	Light Duty	Yes	No	No
PG	Fabricated Perforated	Galvanized Steel	1.65	40"	7.17	.250 Dia.	A	Light Duty	Yes	No	No
PS	Fabricated Perforated	Stainless Steel	1.65	40"	7.17	.250 Dia.	A	Light Duty	Yes	No	No
SWG	Stainless Steel Wire Grate	Stainless Steel	2.70	40"	78.00	0.250	A	Light Duty	Yes	No	No
DOG	Decorative	Ductile Iron	4.57	20"	17.57	0.250	B	Medium Duty	Yes	No	No
HPD	Heel-Proof Longitudinal	Ductile Iron	5.16	20"	15.50	0.250	B	Medium Duty	Yes	No	No
LD	Longitudinal Slotted	Ductile Iron	6.48	20"	20.94	0.5625	B	Medium Duty	No	No	No
SCD	Circular Decorative	Stainless Steel	5.46	20"	6.80	0.250	B	Medium Duty	Yes	No	No
SDD	Diagonal Decorative	Stainless Steel	5.19	20"	15.20	0.250	B	Medium Duty	Yes	No	No

All gratings for the 6" systems have a width of 5.375" and a height of 3/4". For grate definitions and classifications, see page 37.



AWG/SWG



BZ/DOG/SOG



GG

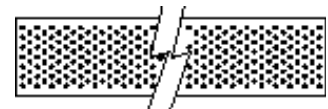

PG/PS



BCD/DCD/SCD

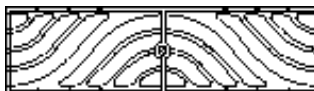

DWV

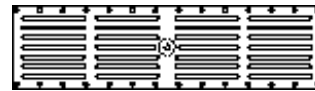

HPB/HPS

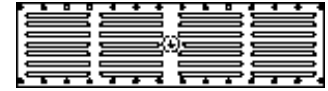

HPD



BDD/DDD/SDD



FG/FS

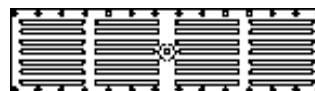

HPP

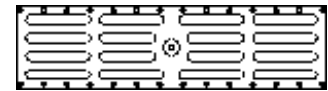

LD

 Indicates 40" Grate Length

6" System Grates											
Suffix	Description	Material	Weight (lbs./ft.)	Length	Open Area (sq. in. per ft.)	Slot Width/ Hole Size	DIN	ANSI	ADA	H-20	FAA
SOG	Decorative	Stainless Steel	5.21	20"	17.57	0.250	B	Medium Duty	Yes	No	No
RFG	Reinforced Slotted	Galvanized Steel	3.18	40"	13.68	0.375	B	Medium Duty	No	No	No
RFS	Reinforced Slotted	Stainless Steel	3.18	40"	13.68	0.375	B	Medium Duty	No	No	No
RPG	Reinforced Perforated	Galvanized Steel	2.46	40"	7.17	.250 Dia.	B	Medium Duty	Yes	No	No
RPS	Reinforced Perforated	Stainless Steel	2.46	40"	7.17	.250 Dia.	B	Medium Duty	Yes	No	No
BG	Slotted Bar Grate	Galvanized Ductile Iron	5.55	20"	23.93	0.3125	C	Medium Duty	No	No	No
DBG	Slotted Bar Grate	Ductile Iron	5.55	20"	23.93	0.3125	C	Special Duty	No	No	No
DCD	Circular Decorative	Ductile Iron	4.80	20"	6.80	0.250	C	Heavy Duty	Yes	No	No
DGC	Slotted Grate	Ductile Iron	4.50	20"	18.57	0.500	C	Heavy Duty	No	No	No
HDD	Fixed Grate	Ductile Iron	16.20	20"	39.22	1.750	C	Heavy Duty	No	Yes	No
HHS	Slotted Grate	Ductile Iron	12.30	20"	5.42	0.910	C	Heavy Duty	Yes	Yes	No
HR	Removable Grate	Ductile Iron	13.00	20"	33.53	1.750	C	Heavy Duty	No	Yes	No
PPC	Perforated Grate	Vinylester	3.30	20"	3.84	0.300	C	Heavy Duty	Yes	No	No
PVS	Slotted Grate	Fabricated Steel	4.60	40"	6.00	0.500	C	Heavy Duty	No	No	No
DCE	Solid Cover	Ductile Iron	7.98	20"	N/A	N/A	E	Special Duty	No	No	Yes
DGE	Slotted Grate	Ductile Iron	6.36	20"	18.57	0.500	E	Special Duty	No	No	Yes
GDE	Slotted Grate	Galvanized Ductile Iron	6.36	20"	18.57	0.500	E	Special Duty	No	No	Yes
SBG	Slotted Bar Grate	Stainless Steel	9.43	20"	28.58	0.500	E	Special Duty	No	No	No
FGF	Ductile Frame & Grate	Ductile Iron	16.20	20"	21.00	0.500	F	Special Duty	No	Yes	Yes
GFG	Galvanized Frame & Grate	Galvanized Ductile Iron	18.20	20"	21.00	0.500	F	Special Duty	No	Yes	Yes

All gratings for the 6" systems have a width of 5.375" and a height of 3/4". For grate definitions and classifications, see page 37.

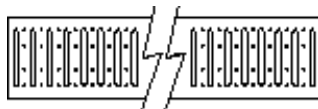

RFG/RFS

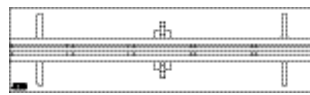

HHS

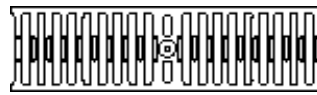

DGE/GDE

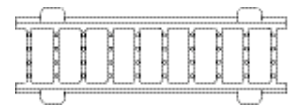

HDD

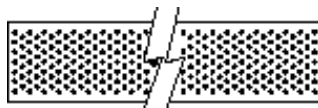

RPG/RPS



PPC



SBG

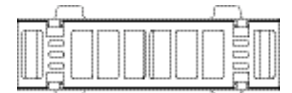

HR



BG/DBG



PVS



FGF/GFG



DGC



DCE

Indicates 40" Grate Length

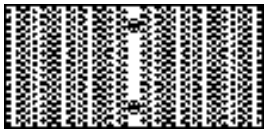

PG/PS

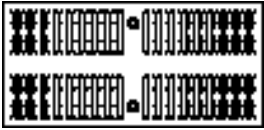

FG/FS

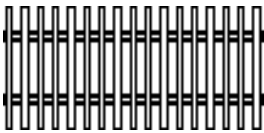

GG

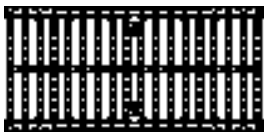

DGC

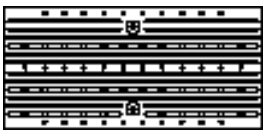

HPD

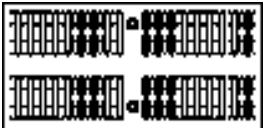

RFG/RFS



RPG/RPS

12" System Grates

Suffix	Description	Material	Weight (lbs./ft.)	Length	Open Area (sq. in. per ft.)	Slot Width/ Hole Size	DIN	ANSI	ADA	H-20	FAA
PG	Fabricated Perforated	Galvanized Steel	6.95	24"	14.00	.250 Dia.	A	Light Duty	Yes	No	No
FG	Fabricated Slotted	Galvanized Steel	6.55	24"	25.61	0.375	B	Light Duty	No	No	No
FS	Fabricated Slotted	Stainless Steel	6.55	24"	25.61	0.375	B	Medium Duty	No	No	No
GG	Slotted Grate	Fiberglass	2.80	24"	73.50	0.875	B	Medium Duty	No	No	No
PS	Fabricated Perforated	Stainless Steel	6.95	24"	14.00	.250 Dia.	B	Medium Duty	Yes	No	No
DGC	Slotted Grate	Ductile Iron	21.00	24"	57.50	0.810	C	Heavy Duty	No	No	No
HPD	Heel-Proof Longitudinal	Ductile Iron	14.40	24"	26.94	0.250	C	Heavy Duty	Yes	No	No
RFG	Reinforced Slotted	Galvanized Steel	10.60	24"	25.61	0.375	C	Heavy Duty	No	No	No
RFS	Reinforced Slotted	Stainless Steel	10.60	24"	25.61	0.375	C	Heavy Duty	No	No	No
RPG	Reinforced Perforated	Galvanized Steel	10.65	24"	14.00	.250 Dia.	C	Heavy Duty	Yes	No	No
RPS	Reinforced Perforated	Stainless Steel	10.65	24"	14.00	.250 Dia.	C	Heavy Duty	Yes	No	No
BG	Slotted Bar Grate	Galvanized Steel	13.30	24"	101.00	0.750	D	Heavy Duty	No	No	No
SBG	Slotted Bar Grate	Stainless Steel	13.30	24"	101.00	0.750	D	Heavy Duty	No	No	No
DC	Solid Cover	Ductile Iron	17.45	24"	N/A	N/A	E	Special Duty	No	No	Yes
DGE	Slotted Grate	Ductile Iron	21.50	24"	57.00	0.740	E	Special Duty	No	Yes	Yes
DGF	Slotted Grate	Ductile Iron	27.00	24"	57.00	0.688	F	Special Duty	No	Yes	Yes

All gratings for the 12" systems have a width of 11-1/4" and a height of 1-1/2". For grate definitions and classifications, see page 37.



BG/SBG

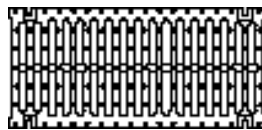

DGE/DGF

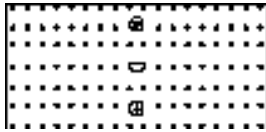

DC

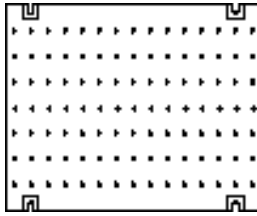

DCC

Z874-12 System Grates

Suffix	Description	Material	Weight (lbs./ft.)	Length	Open Area (sq. in. per ft.)	Slot Width/ Hole Size	DIN	ANSI	ADA	H-20	FAA
DCC	Solid Cover	Ductile Iron	29.00	20"	N/A	N/A	C	Heavy Duty	Yes	Yes	No
DGC	Slotted Grate	Ductile Iron	27.00	20"	118.00	.950	C	Heavy Duty	No	Yes	No
HPD	Heel-Proof Longitudinal	Ductile Iron	29.00	20"	37.07	.250	C	Heavy Duty	Yes	Yes	No
DGF	Slotted Grate	Ductile Iron	49.00	20"	90.00	.740	F	Special Duty	No	Yes	Yes

All gratings for the Z874-12 system have a width of 16-1/4" and a height of 1-3/4". For grate definitions and classifications, see page 37.

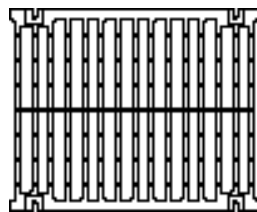

DGC

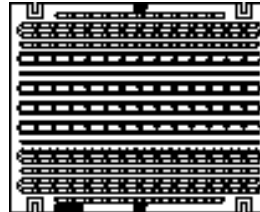

HPD

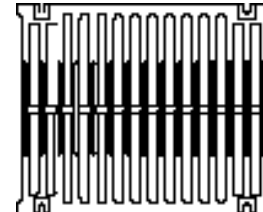

DGF

For downloadable CSI format specification, visit www.zurn.com.

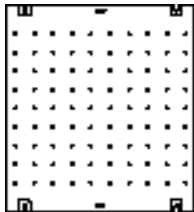

DCC

Z874-18 System Grates

Suffix	Description	Material	Weight (lbs./ft.)	Length	Open Area (sq. in. per ft.)	Slot Width/ Hole Size	DIN	ANSI	ADA	H-20	FAA
DCC	Solid Cover	Ductile Iron	57.00	20"	N/A	N/A	C	Heavy Duty	Yes	Yes	No
DGC	Slotted Grate	Ductile Iron	54.00	20"	112.00	1.030	C	Heavy Duty	No	Yes	No
HPD	Heel-Proof Longitudinal	Ductile Iron	56.00	20"	26.31	.250	C	Heavy Duty	Yes	Yes	No
DGF	Slotted Grate	Ductile Iron	77.00	20"	94.00	0.870	F	Special Duty	No	Yes	Yes

All gratings for the Z874-18 system have a width of 22-1/4" and a height of 1-3/4". For grate definitions and classifications, see page 37.

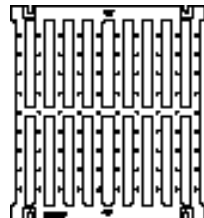

DGC

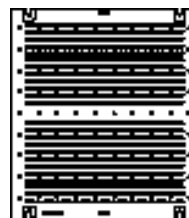

HPD

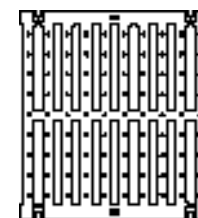

DGF

For downloadable CSI format specification, visit www.zurn.com.

Note: Ductile iron grating for Z874-12 and Z874-18 are furnished unpainted. Painted option available.

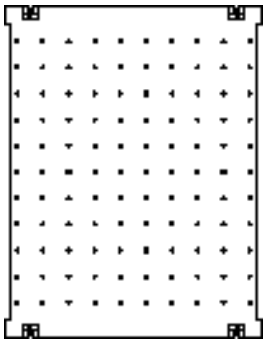

DCC

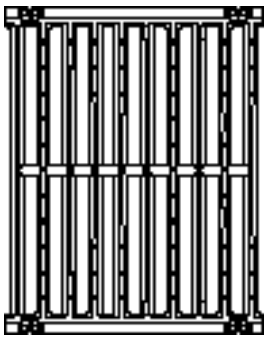

DGC

Z874-21 System Grates

Suffix	Description	Material	Weight (lbs./ft.)	Length	Open Area (sq. in. per ft.)	Slot Width/ Hole Size	DIN	ANSI	ADA	H-20	FAA
DCC	Solid Cover	Ductile Iron	58.00	20"	N/A	N/A	C	Heavy Duty	Yes	Yes	No
DGC	Slotted Grate	Ductile Iron	54.00	20"	133.00	1.030	C	Heavy Duty	No	Yes	No
HPD	Heel-Proof Longitudinal	Ductile Iron	56.00	20"	30.74	.250	C	Heavy Duty	Yes	Yes	No
DGF	Slotted Grate	Ductile Iron	90.00	20"	112.00	0.870	F	Special Duty	No	Yes	Yes

All gratings for the Z874-21 system have a width of 25-1/2" and a height of 1-3/4". For grate definitions and classifications, see page 37.

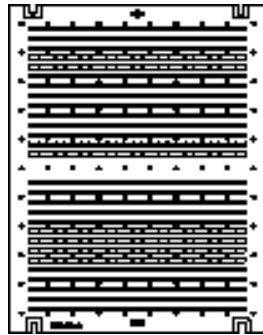

HPD

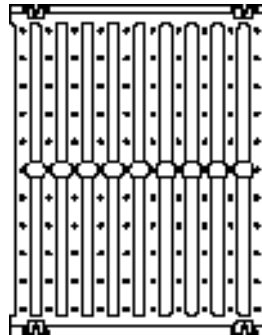

DGF

For downloadable CSI format specification, visit www.zurn.com.

Note: Ductile iron grating for Z874-21 is furnished unpainted. Painted option available.



BZ



FG/FS



HPP



PG/PS



CG

Z884 4" System Grates

Suffix	Description	Material	Weight (lbs./ft.)	Length	Open Area (sq. in. per ft.)	Slot Width/ Hole Size	DIN	ANSI	ADA	H-20	FAA
BZ	Bronze Decorative	Bronze	4.05	20"	11.62	0.250	A	Light Duty	Yes	No	No
FG	Fabricated Slotted	Galvanized Steel	2.79	40"	7.80	0.375	A	Light Duty	No	No	No
FS	Fabricated Slotted	Stainless Steel	2.88	40"	7.80	0.375	A	Light Duty	No	No	No
HPP	Heel-Proof Slotted	HDPE	0.69	20"	10.78	0.250	A	Light Duty	Yes	No	No
PG	Fabricated Perforated	Galvanized Steel	2.67	40"	N/A	.250 Dia.	A	Light Duty	Yes	No	No
PS	Fabricated Perforated	Stainless Steel	2.82	40"	N/A	.250 Dia.	A	Light Duty	Yes	No	No
CG	Slotted Grate	Cast Iron	5.16	20"	12.50	0.375	C	Medium Duty	No	No	No

All gratings for the Z884 system have a width of 4-1/8" and a height of 3/4". For grate definitions and classifications, see page 37.

For downloadable CSI format specification, visit www.zurn.com.

 Indicates 40" Grate Length

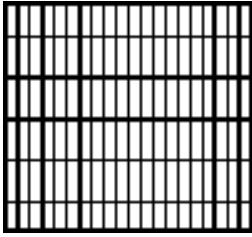

BG/SBG

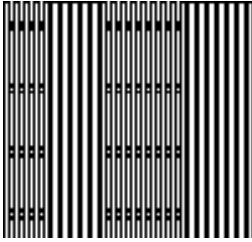

GG

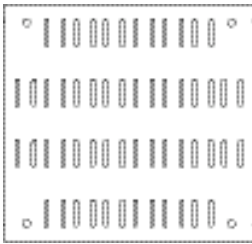

RFG/RFS

Z817 and Z887 24" x 24" System Grates

Suffix	Description	Material	Weight (lbs.)	Open Area (sq. in. per ft.)	Slot Width/ Hole Size	DIN	ANSI	ADA	H-20	FAA
BG	Slotted Bar Grate	Galvanized Steel	39.00	445.00	1.188	A	Light Duty	No	No	No
GG	Slotted Grate	Fiberglass	11.50	200.00	0.375	A	Light Duty	No	No	No
RFG	Reinforced Slotted	Galvanized Steel	46.70	64.00	0.380	A	Light Duty	Yes	No	No
RFS	Reinforced Slotted	Stainless Steel	48.00	64.00	0.380	A	Light Duty	Yes	No	No
RPG	Reinforced Perforated	Galvanized Steel	46.70	62.83	0.250	A	Light Duty	Yes	No	No
RPS	Reinforced Perforated	Stainless Steel	48.00	62.83	0.250	A	Light Duty	Yes	No	No
SBG	Slotted Bar Grate	Stainless Steel	39.00	445.00	1.188	A	Light Duty	No	No	No
DGC	Slotted Grate	Ductile Iron	96.00	164.00	0.344	C	Heavy Duty	No	Yes	No
DGF	Slotted Grate	Ductile Iron	118.00	153.00	0.344	F	Special Duty	No	Yes	Yes

All gratings for the Z817 and Z887 systems have a width of 24" and a height of 1-7/16". For grate definitions and classifications, see page 37.

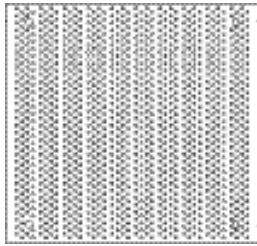

RPG/RPS

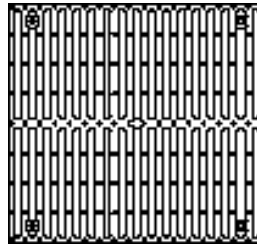

DGC

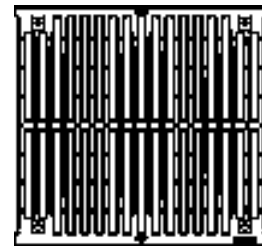

DGF

For downloadable CSI format specification, visit www.zurn.com.

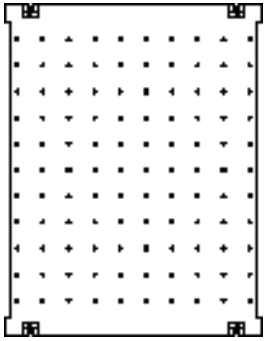

DCC

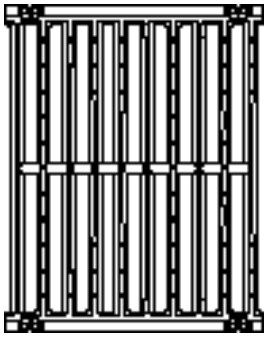

DGC

Z874-21 System Grates

Suffix	Description	Material	Weight (lbs./ft.)	Length	Open Area (sq. in. per ft.)	Slot Width/ Hole Size	DIN	ANSI	ADA	H-20	FAA
DCC	Solid Cover	Ductile Iron	58.00	20"	N/A	N/A	C	Heavy Duty	Yes	Yes	No
DGC	Slotted Grate	Ductile Iron	54.00	20"	133.00	1.030	C	Heavy Duty	No	Yes	No
HPD	Heel-Proof Longitudinal	Ductile Iron	56.00	20"	30.74	.250	C	Heavy Duty	Yes	Yes	No
DGF	Slotted Grate	Ductile Iron	90.00	20"	112.00	0.870	F	Special Duty	No	Yes	Yes

All gratings for the Z874-21 system have a width of 25-1/2" and a height of 1-3/4". For grate definitions and classifications, see page 37.

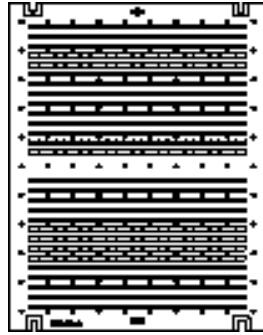

HPD

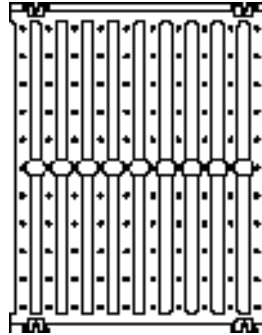

DGF

For downloadable CSI format specification, visit www.zurn.com.

Note: Ductile iron grating for Z874-21 is furnished unpainted. Painted option available.



BZ

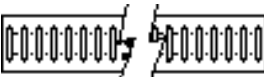

FG/FS



HPP



PG/PS



CG

Z884 4" System Grates

Suffix	Description	Material	Weight (lbs./ft.)	Length	Open Area (sq. in. per ft.)	Slot Width/ Hole Size	DIN	ANSI	ADA	H-20	FAA
BZ	Bronze Decorative	Bronze	4.05	20"	11.62	0.250	A	Light Duty	Yes	No	No
FG	Fabricated Slotted	Galvanized Steel	2.79	40"	7.80	0.375	A	Light Duty	No	No	No
FS	Fabricated Slotted	Stainless Steel	2.88	40"	7.80	0.375	A	Light Duty	No	No	No
HPP	Heel-Proof Slotted	HDPE	0.69	20"	10.78	0.250	A	Light Duty	Yes	No	No
PG	Fabricated Perforated	Galvanized Steel	2.67	40"	N/A	.250 Dia.	A	Light Duty	Yes	No	No
PS	Fabricated Perforated	Stainless Steel	2.82	40"	N/A	.250 Dia.	A	Light Duty	Yes	No	No
CG	Slotted Grate	Cast Iron	5.16	20"	12.50	0.375	C	Medium Duty	No	No	No

All gratings for the Z884 system have a width of 4-1/8" and a height of 3/4". For grate definitions and classifications, see page 37.

For downloadable CSI format specification, visit www.zurn.com.

 Indicates 40" Grate Length

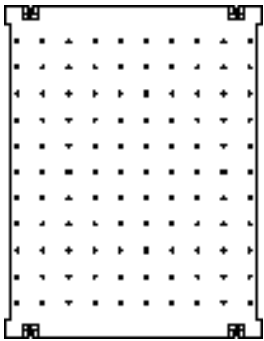

DCC

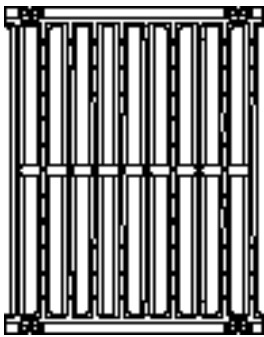

DGC

Z874-21 System Grates

Suffix	Description	Material	Weight (lbs./ft.)	Length	Open Area (sq. in. per ft.)	Slot Width/ Hole Size	DIN	ANSI	ADA	H-20	FAA
DCC	Solid Cover	Ductile Iron	58.00	20"	N/A	N/A	C	Heavy Duty	Yes	Yes	No
DGC	Slotted Grate	Ductile Iron	54.00	20"	133.00	1.030	C	Heavy Duty	No	Yes	No
HPD	Heel-Proof Longitudinal	Ductile Iron	56.00	20"	30.74	.250	C	Heavy Duty	Yes	Yes	No
DGF	Slotted Grate	Ductile Iron	90.00	20"	112.00	0.870	F	Special Duty	No	Yes	Yes

All gratings for the Z874-21 system have a width of 25-1/2" and a height of 1-3/4". For grate definitions and classifications, see page 37.

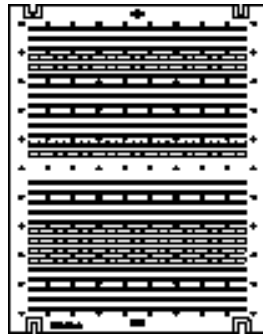

HPD

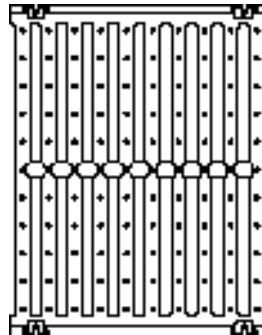

DGF

For downloadable CSI format specification, visit www.zurn.com.

Note: Ductile iron grating for Z874-21 is furnished unpainted. Painted option available.



BZ

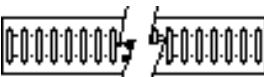

FG/FS



HPP



PG/PS



CG

Z884 4" System Grates

Suffix	Description	Material	Weight (lbs./ft.)	Length	Open Area (sq. in. per ft.)	Slot Width/ Hole Size	DIN	ANSI	ADA	H-20	FAA
BZ	Bronze Decorative	Bronze	4.05	20"	11.62	0.250	A	Light Duty	Yes	No	No
FG	Fabricated Slotted	Galvanized Steel	2.79	40"	7.80	0.375	A	Light Duty	No	No	No
FS	Fabricated Slotted	Stainless Steel	2.88	40"	7.80	0.375	A	Light Duty	No	No	No
HPP	Heel-Proof Slotted	HDPE	0.69	20"	10.78	0.250	A	Light Duty	Yes	No	No
PG	Fabricated Perforated	Galvanized Steel	2.67	40"	N/A	.250 Dia.	A	Light Duty	Yes	No	No
PS	Fabricated Perforated	Stainless Steel	2.82	40"	N/A	.250 Dia.	A	Light Duty	Yes	No	No
CG	Slotted Grate	Cast Iron	5.16	20"	12.50	0.375	C	Medium Duty	No	No	No

All gratings for the Z884 system have a width of 4-1/8" and a height of 3/4". For grate definitions and classifications, see page 37.

For downloadable CSI format specification, visit www.zurn.com.

 Indicates 40" Grate Length