

Oil/Water Separator Operating & Maintenance Manual

For Single-Wall and Double-Wall
Fiberglass Underground Storage Tanks

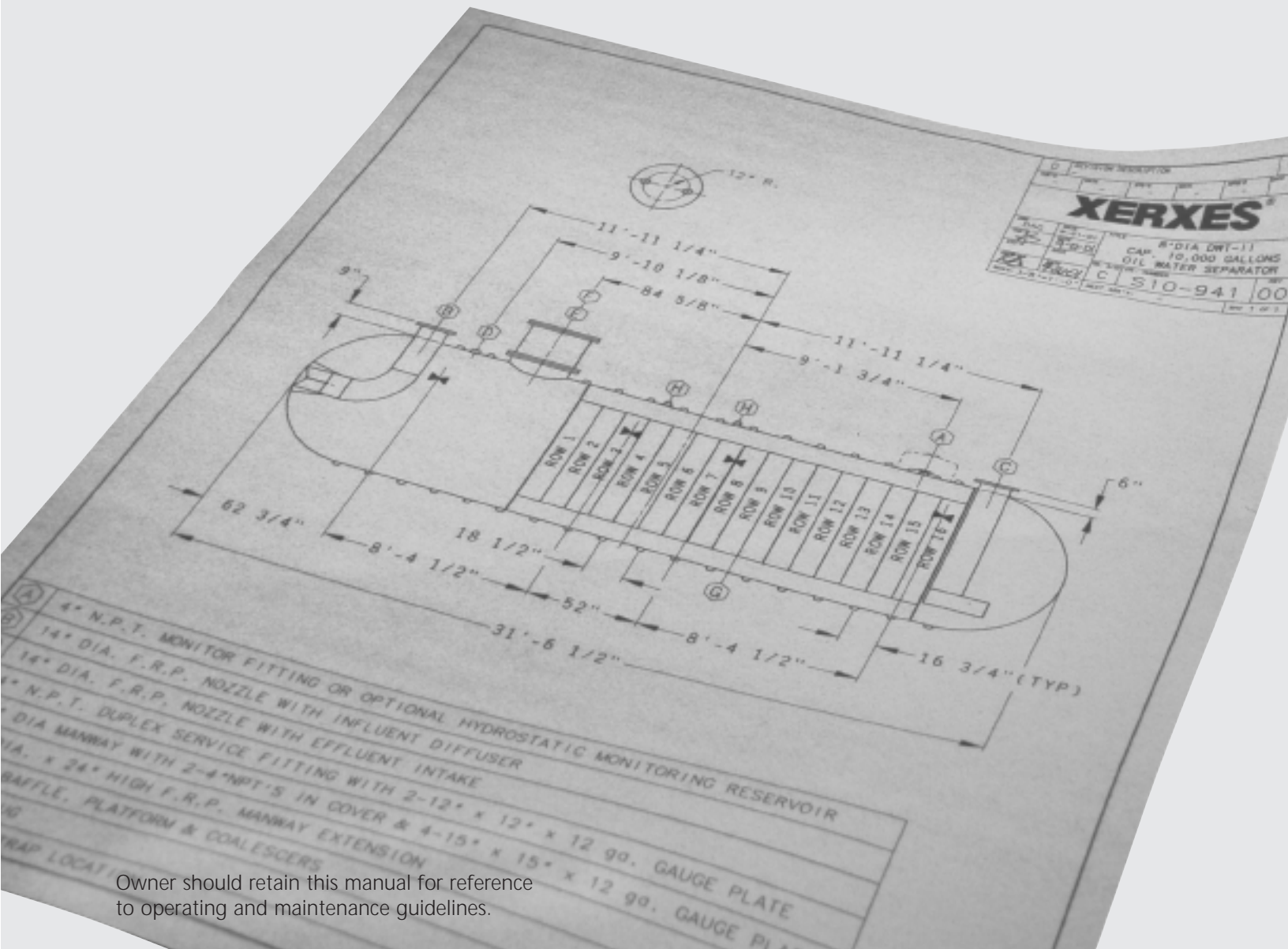

This Oil/Water Separator (OWS) Operating and Maintenance Manual gives instructions for single-wall and double-wall OWS applications. It must be used in combination with the Xerxes Installation Manual and Operating Guidelines for Single-Wall and Double-Wall Fiberglass Underground Storage Tanks.

TABLE OF CONTENTS

<p>Section 1 Introduction.....p.2 1.1. Safety 1.2. General 1.3. Definitions</p> <p>Section 2 Preparation for Installation.....p.3 2.1. General</p> <p>Section 3 Preinstallation Testing.....p.3 3.1. General</p> <p>Section 4 Backfill Material.....p.4 4.1. General</p> <p>Section 5 Excavation Parameters.....p.4 5.1. General</p> <p>Section 6 Anchoring Tanks.....p.4 6.1. General</p> <p>Section 7 Installation.....p.4 7.1. General</p> <p>Section 8 Piping.....p.4 8.1. General</p> <p>Section 9 Venting.....p.4 9.1. General</p> <p>Section 10 Postinstallation Testing.....p.4 10.1. General</p> <p>Section 11 Filling the OWS.....p.5 11.1. General</p> <p>Section 12 Connecting the OWS to Sensor.....p.5 12.1. General</p>	<p>Section 13 Operating the OWS.....p.5 13.1. General 13.2. Removing Oil</p> <p>Section 14 Maintaining the OWS.....p.6 14.1. General 14.2. Cleaning the OWS 14.3. Optional Process for Cleaning the OWS 14.4. Inspecting the OWS</p> <p>Section 15 Removing and Cleaning the Coalescer....p.7 15.1. Removing and Cleaning 4-Foot-Diameter OWS Coalescer 15.2. Removing and Cleaning 6-Foot-Diameter OWS Coalescer 15.3. Removing and Cleaning 8-Foot-Diameter and 10-Foot-Diameter OWS Coalescer 15.4. Cleaning the Coalescer Pack</p> <p>Section 16 Handling A Major Oil Spill.....p.9 16.1. General</p> <p>Section 17 Operating Guidelines.....p.10 17.1. General</p> <p>Section 18 Limited Warranties.....p.10 18.1. General</p> <p>Section 19 Selected List of Supplemental Materials...p.10 19.1. General</p> <p>Section 20 Retaining the OWS Manual.....p.10 20.1. General</p> <p>Addendum OWS Nominal Oil Storage Capacity and Oil/Water Interface Levels Chart.....p.11</p>
--	---

Read all instructions before installing oil/water separator (OWS).

To Installer:

Before OWS installation, read Xerxes OWS Operating and Maintenance Manual and Xerxes Installation Manual and Operating Guidelines for Single-Wall and Double-Wall Fiberglass Underground Storage Tanks. After OWS installation, give both manuals to OWS owner.

To Owner:

After OWS installation, retain Xerxes OWS Operating and Maintenance Manual and Xerxes Installation Manual and Operating Guidelines for Single-Wall and Double-Wall Fiberglass Underground Storage Tanks for future reference to operating and maintenance guidelines.

1. INTRODUCTION

1.1. SAFETY

1.1.1. Before beginning the oil/water separator (subsequently referred to as "OWS") installation, read through the entire OWS Operating and Maintenance Manual (subsequently referred to as "OWS Manual") and the Xerxes Installation Manual and Operating Guidelines for Single-Wall and Double-Wall Fiberglass Underground Storage Tanks (subsequently referred to as "Installation Manual"). It is the responsibility of the owner, installer and operator to follow all requirements contained in this OWS Manual and the Installation Manual, and comply with all federal, state and local regulations that may apply to OWS installations, operations and maintenance.

1.1.2. No instructions or procedures presented in this OWS Manual and the Installation Manual should be interpreted so as to put at risk any person's health or safety, or to harm any property or the environment.

1.1.3. The following definitions will serve as a guide when reading the OWS Manual:

⚠ WARNING

Indicates a potentially hazardous situation, which, if not avoided, could result in death or serious injury.

⚠ CAUTION

Indicates a potentially hazardous situation, which, if not avoided, may result in minor or moderate injury.

CAUTION

A Caution without the safety alert symbol indicates a potentially hazardous situation, which, if not avoided, may result in property damage.

1.1.4. Keep this OWS Manual and the Installation Manual available at the installation site to refer to safety procedures as needed.

1.1.5. A Xerxes oil/water separator is a high-quality system for removing oil from water. It is comprised of a standard single-

wall or double-wall tank that has been modified with piping and internal components to separate oil from water.

1.2. GENERAL

1.2.1. It is important to follow the procedures and instructions in both this OWS Manual and the Installation Manual in order to safely and properly install, operate and maintain a Xerxes oil/water separator and accessories. Failure to follow these instructions will void the OWS warranty, and may cause OWS failure, serious personal injury or property damage.

1.2.2. The Xerxes warranty applies only to an OWS installed according to the instructions contained in this OWS Manual and the Installation Manual. Since Xerxes does not control the parameters of any installation, Xerxes' sole responsibility in any installation is that presented in our warranty.

1.2.3. It is the responsibility of the owner and operator to always follow the operating and maintenance guidelines set forth in Xerxes' applicable warranty and SECTION 18 of the Installation Manual. A Xerxes warranty is found in the product brochure or is available upon request from the UST coordinator at the Xerxes plant nearest you. It is the responsibility of the owner to retain this OWS Manual and the Installation Manual for future reference to operating and maintenance guidelines.

1.2.4. Use the Tank Installation Checklist (included in the Installation Manual) as the installation proceeds. Retain a copy of the completed Tank Installation Checklist, and any correspondence, certification, etc., related to the OWS. Each OWS requires a separate Tank Installation Checklist. Consult your Xerxes representative or distributor if additional Tank Installation Checklist forms are needed.

1.2.5. The OWS owner should retain a copy of the Tank Installation Checklist to facilitate any warranty claim. Xerxes recommends that the installing contractor also retain a copy.

1.2.6. For additional information, contact your state, county and city authorities, including health, fire or building departments, and environmental agencies. All work must be performed according to standard industry practices and OSHA regulations.

1.2.7. Comply with all applicable regulations and standards regarding the disposal of separated oil and solids.

1.2.8. Federal, state and local codes and regulations always take precedence over a Xerxes requirement.

1.2.9. Xerxes must authorize – in writing and prior to OWS installation – any variation to, or deviation from, these OWS Manual instructions.

1.2.10. All correspondence regarding variations must be retained.

1.2.11. If you have questions or encounter situations not covered in this OWS Manual or the Installation Manual, contact technical support at Xerxes Minneapolis, 952-887-1890.

1.3. DEFINITIONS

1.3.1. For terms related to the Xerxes OWS, see *FIGURE 1-1* (for 4-foot-diameter OWS), *FIGURE 1-2* (for 6-foot-diameter OWS) and *FIGURE 1-3* (for 8-foot-diameter OWS and 10-foot-diameter OWS). These drawings are for purposes of terminology only.

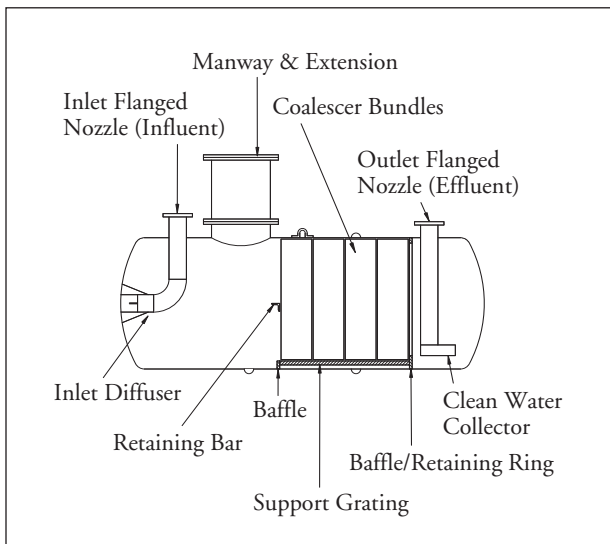

FIGURE 1-1

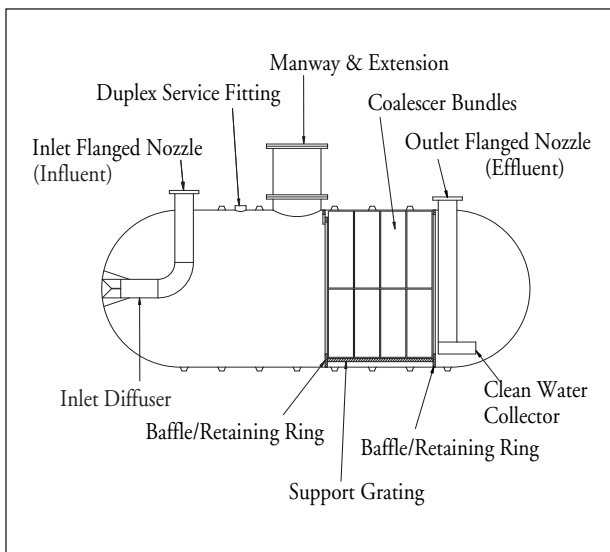

FIGURE 1-2

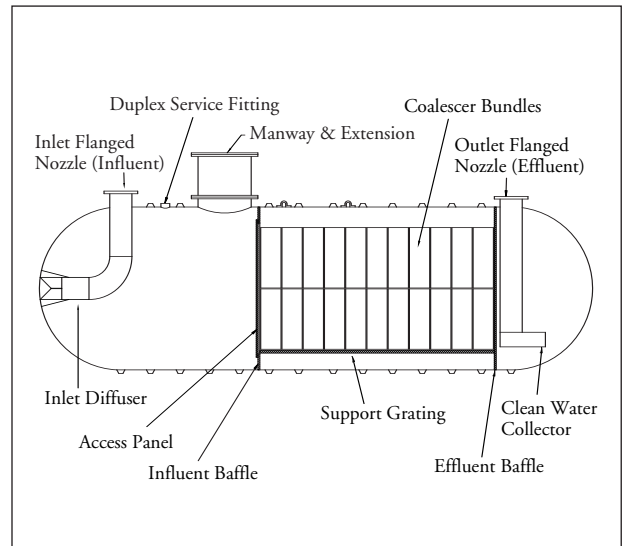

FIGURE 1-3

1.3.2. Nominal oil storage is defined as the maximum amount of oil the Xerxes OWS can store (recover) while maintaining the performance specifications for which the OWS was designed.

1.3.3. Emergency spill capacity is defined as the maximum amount of oil the Xerxes OWS can store (capture) in an emergency spill situation. This capacity includes the nominal oil storage in the OWS at the time of the spill. Exceeding this capacity may lead to a sudden oil release.

Note: If the nominal oil storage capacity is exceeded (which can occur in emergency spill situations) in high-flow conditions, the effluent quality may not meet Xerxes’ performance specifications.

2. PREPARATION FOR INSTALLATION

2.1. GENERAL

2.1.1. Although Xerxes oil/water separators are rugged, the OWS owner and/or tank owner’s representative must take care so that the OWS is not dropped or damaged during delivery, unloading and handling on the job site.

2.1.2. See Installation Manual for specific instructions on unloading and handling the OWS on the job site.

2.1.3. See Installation Manual for specific instructions on inspecting the OWS prior to installation.

2.1.4. In addition, remove the manway cover and inspect baffles, coalescer and internal piping for damage.

3. PREINSTALLATION TESTING

3.1. GENERAL

3.1.1. See Installation Manual for instructions on testing the OWS tank on the job site.

4. BACKFILL MATERIAL

4.1. GENERAL

4.1.1. See Installation Manual for backfill instructions.

4.1.2. In addition, avoid freeze damage to the OWS by installing the OWS so that the highest liquid level (most frequently, the height of the inlet and outlet tee/elbow) is below the frost line, and/or by installing a temperature-activated heating device (with appropriate overheat prevention) at the highest liquid-level point.

CAUTION

Do not exceed 120° F temperature in the OWS or its contents. Excessive heat in the OWS may result in minor or moderate injury, or in failure of or damage to the OWS.

5. EXCAVATION PARAMETERS

5.1. GENERAL

5.1.1. See Installation Manual for excavation instructions.

6. ANCHORING TANKS

6.1. GENERAL

6.1.1. See Installation Manual for anchoring instructions.

7. INSTALLATION

7.1. GENERAL

7.1.1. See Installation Manual for installation instructions.

7.1.2. In addition, install the OWS in one of the following positions: a.) in a level and plumb position, or b.) with the outlet side 1/2 inch to 1 inch lower than the inlet side.

7.1.3. The OWS is designed to be gravity-fed. If an installation requires a lift station, the lift station should be located downstream of the OWS.

8. PIPING

8.1. GENERAL

8.1.1. See Installation Manual for piping instructions.

8.1.2. In addition, follow these instructions:

8.1.2.1. All piping must be properly sized and influent piping must be gravity-fed.

CAUTION

Turbulence caused by improperly sized piping or pumping influent into the OWS may damage the OWS, reduce its efficiency or require flow conditioners to augment the system.

8.1.2.2. Make sure the diameters of the inlet piping and the outlet piping are no larger than the diameters of the inlet nozzle and the outlet nozzle.

8.1.2.3. Install expansion joints or loops on any inlet or outlet tee/elbow connections.

CAUTION

All connections to the OWS must be flexible. Provisions must be made to accommodate movement and misalignment between the piping and the OWS. Failure to do this may damage the tank or surrounding property.

8.1.2.4. Slope the inlet piping to the OWS downward to establish a proper gravity flow.

8.1.2.5. Slope the outlet piping away from the OWS according to job specifications (typically between 1/16 inch and 1/4 inch per foot) to establish a proper gravity flow.

8.1.2.6. Xerxes recommends installing a dropout box large enough to collect debris (such as leaves, gravel, sand, rags, etc.) upstream of the OWS.

8.1.2.7. A butterfly or gate valve can be installed upstream of the inlet tee/elbow connection.

8.1.2.8. An outlet butterfly or gate valve can be installed downstream of the outlet tee/elbow connection.

8.1.2.9. Make sure inlet valves have no valve seat or reductions and are the same size as the piping.

8.1.2.10. To prevent debris from entering the OWS, plug the inlet piping and outlet piping until the drainage site is paved and the dropout box (if present) is installed.

8.1.2.11. If installed, keep the inlet valves completely open during normal operation to prevent flow turbulence.

9. VENTING

9.1. GENERAL

9.1.1. See Installation Manual for venting instructions.

9.1.2. In addition, follow these instructions:

9.1.2.1. Vent the OWS to atmospheric pressure to ensure proper operation.

9.1.2.2. Vent the OWS inlet and outlet piping to atmospheric pressure to ensure proper operation.

9.1.2.3. For instructions on venting an interstitial space (applicable in a double-wall OWS), see the section in Installation Manual on Venting Interstitial Space.

9.1.2.4. Provide flame arrestors when required by regulations and standards, and when appropriate for safety reasons.

10. POSTINSTALLATION TESTING

10.1. GENERAL

10.1.1. Perform any postinstallation testing required by the Installation Manual and by local codes.

11. FILLING THE OWS

11.1. GENERAL

11.1.1. Open the OWS inlet and outlet valves if present.

11.1.2. Fill the OWS through the manway or stormwater inlet piping.

11.1.3. Place the fill hose through the fitting and secure it so it does not spray directly on the coalescer.

11.1.4. Fill the OWS at least half-full with clean water using a garden hose, fire hose or tanker truck.

11.1.5. If probes are present, Xerxes recommends that the OWS be filled completely to check probe operation during a startup.

WARNING

The OWS shall be adequately vented to prevent the development of vacuum or pressure when filling or emptying the tank. Failure to properly vent the OWS could cause tank failure and result in death or serious injury.

12. CONNECTING OWS TO SENSOR (FOR UL 2215 OWS)

12.1. GENERAL

12.1.1. Connect the LS800 sensor to the appropriate panel wiring on the LU2-OWP controller.

12.1.2. Switch on the panel of the LU2-OWP controller.

12.1.3. Check the connection between the sensor and the controller by following this procedure:

12.1.3.1. Keeping the top interface float in its top position, move the bottom interface float up and down on the sensor stem. The high-oil-level alarm light will activate as the bottom float approaches the stem bottom.

12.1.3.2. Move the top interface float up and down. The caution-oil-level alarm light will activate as the top interface float moves off the upper stop.

12.1.3.3. If the alarm lights do not activate and deactivate, check the panel and sensor wiring for proper connections. If the connections appear to be in proper condition but the panel alarm lights do not operate, contact technical support at sensor manufacturer.

12.1.3.4. The caution-oil-level and high-oil-level alarm lights will be activated whenever the OWS is being filled with water, before the water reaches the sensor. If the connections appear to be in proper condition but the panel alarm lights do not operate, contact technical support at sensor manufacturer.

13. OPERATING THE OWS

13.1. GENERAL

13.1.1. Operating the OWS as specified in this OWS Manual

increases the efficiency and effectiveness of the OWS.

13.1.2. Take ordinary fire prevention measures around separated oil to ensure that all flames, sparks, and other ignition devices and materials are kept away from the OWS.

WARNING

Safeguard against sparks or fire in the vicinity of the OWS. Vapors and liquid oil may be flammable and cause a fire or explosion, which could cause death, serious injury or property damage.

13.1.3. The oil/water interface is the point at which oil is detected above the water. Oil will be floating on the water. The accumulated oil should be pumped out of the OWS if the oil/water interface is below the levels listed in TABLE 13-1. (See page 11 of this OWS Manual.)

13.1.3.1. The nominal oil storage capacity shown in TABLE 13-1 does not include oil that may accumulate within the manways or fittings. Add the amount in the manways and/or fittings to the figure listed as the nominal oil storage capacity when you calculate oil storage capacity.

CAUTION

If the oil is not pumped out after reaching the level indicated in TABLE 13-1, and more oily water enters the OWS, the effluent oil concentration may exceed allowable levels. Exceeding the nominal oil storage level may result in environmental contamination, property damage, damage to the OWS or loss of efficiency of the OWS.

13.1.4. Check oil level after every rainstorm or in accordance with local codes.

13.1.5. Dispose of oil from the OWS as required by federal, state and local regulations and codes.

CAUTION

Do not collect "waste" oils in the OWS as they may contain chemicals that may damage the OWS, piping and internal components.

13.2. REMOVING OIL

13.2.1. Remove oil only during non-flow conditions so that only oil is drawn off.

13.2.2. Remove the oil before the oil accumulates to the level given in TABLE 13-1. (See page 11 of this OWS Manual.)

13.2.3. To determine oil level in a non-alarm situation, use the following procedure:

13.2.3.1. Apply oil/water sensing paste to a gauge stick.

13.2.3.2. Insert the gauge stick into the OWS through the 4-inch fitting or manway to determine the oil/water interface location.

13.2.3.3. If the oil/water interface level is below the level specified for each OWS model in TABLE 13-1, pump out oil.

13.2.4. To remove oil if the optional alarm is activated follow this procedure:

13.2.4.1. If the oil/water interface level is below the level specified for each OWS model in TABLE 13-1, pump out oil.

13.2.4.2. The optional alarm may stay on until the water level in the OWS is high enough to deactivate it.

13.2.5. After pumping out oil, charge the OWS with clean water to deactivate the alarm lights by following instructions in SECTION 11 or wait until the next rainfall, which should deactivate the alarm lights.

14. MAINTAINING THE OWS

14.1. GENERAL

14.1.1. The OWS requires regular maintenance, including the following cleaning and inspection procedures, to operate most efficiently and effectively.

WARNING

Never enter the OWS, the riser, the manway extension or any other enclosed space without proper training and OSHA-approved equipment. See OSHA guidelines 29 CFR, Part 1910 "Permit Required Confined Spaces." Failure to follow this warning could result in death or serious injury.

WARNING

Ventilate all enclosed spaces according to methods described in applicable regulations and codes before entering an OWS to avoid asphyxiation or ignition of vapors or liquid oil, which are flammable. Failure to properly ventilate could result in death or serious injury.

WARNING

OWS interior surfaces are slippery. A slip or fall could result in death or serious injury.

14.1.2. Perform maintenance at least once a year.

14.1.3. Under the following conditions, maintenance is required more frequently:

- if the OWS bottom sludge accumulation is more than 12 inches deep;
- when the effluent water exceeds the effluent quality level mandated by applicable federal, state and local codes and regulations;
- after a major oil spill has occurred (See SECTION 16.).

14.2. CLEANING THE OWS

14.2.1. Begin maintenance by cleaning the OWS, using the following procedure:

14.2.1.1. Remove all liquid from the OWS before entering the OWS.

CAUTION

Properly dispose of oil removed from the OWS as required by federal, state and local laws, codes and regulations.

14.2.1.2. Close inlet and outlet piping valves if present or plug the piping before entering the OWS.

WARNING

Failure to close inlet and outlet piping valves or plug the piping before entering the OWS could result in death or serious injury.

14.2.1.3. Remove the coalescer for cleaning. (See SECTION 15 for instructions.)

WARNING

Do not stand on the coalescer support grating. This grating is slippery and a slip or fall could result in death or serious injury.

14.2.1.4. Suction or shovel out sludge and debris from the OWS.

CAUTION

Do not use picks, axes, hammers or other heavy tools or objects when breaking apart sludge in the OWS. Such tools may damage the OWS.

CAUTION

When using a shovel to remove sludge, do not strike the OWS. Striking the OWS may damage it.

14.2.1.5. Loosen any caked oily solids in the OWS by spraying with a standard garden hose (with or without a spray nozzle) at a pressure between 40 and 70 psig.

14.2.1.6. Use hot water for best results. Do not use detergent or soap.

CAUTION

Do not use soaps or detergents when cleaning the coalescers. Soaps or detergents may damage the coalescers and/or reduce the efficiency of the OWS.

14.2.1.7. Aim the flow of water at the OWS walls — top, sides and bottom.

14.2.1.8. Shovel out the slurry, being careful not to damage the OWS.

14.2.1.9. Check the oil/water sensor (if installed) for movement.

14.2.1.10. Remove and clean the sensor if the floats do not easily slide on the stem or if there is sludge on the floats.

14.2.1.11. Visually inspect the OWS interior (walls, components and inlet piping) for damage. If you observe any damage, contact the Xerxes manufacturing facility from which the OWS was shipped. (See *telephone numbers on back of OWS Manual.*)

14.2.1.12. Install the cleaned coalescer packs, support grating and retaining pieces by reversing the steps as shown in SECTION 15.

14.2.1.13. If the coalescer packs are not properly installed, the OWS will not work properly or efficiently.

CAUTION

Check to see that the coalescer packs, support grating and retaining pieces are reinstalled properly. Improper installation may result in damage to the OWS and/or reduce its efficiency.

14.2.1.14. Attach the manway lid.

14.2.1.15. Check to see that the gaskets are not damaged.

14.2.1.16. Replace gaskets as necessary.

14.2.1.17. Charge the OWS by filling it half-full with clean water. (See SECTION 11 for instructions.)

14.2.1.18. Restart the OWS. (See SECTION 11 for instructions.)

14.3. OPTIONAL PROCESS FOR CLEANING THE OWS

14.3.1. If it has been less than one year since the last OWS cleaning, and if only the bottom sludge has built up and the effluent water is contaminant-free, the following procedure may be sufficient for proper maintenance:

14.3.1.1. Pump out sludge from inlet chamber.

14.3.1.2. Pump out sludge from under the vertical-tube coalescer packs.

14.3.1.3. Charge the OWS by filling it half-full with clean water. (See SECTION 11 in this OWS Manual.)

14.4. INSPECTING THE OWS

14.4.1. Continue maintenance by performing the following inspections as usage and environment requires:

14.4.1.1. Inspect and clean the dropout boxes.

14.4.1.2. Inspect the inside of the OWS for sand, trash, sludge and oil build-up.

14.4.1.3. Inspect effluent water for oils or other contaminants during or immediately after a heavy rainfall.

14.4.1.4. Inspect gaskets when the OWS is shut down for maintenance.

15. REMOVING AND CLEANING THE COALESCER

CAUTION

Keep coalescers covered or out of contact with ultraviolet light. Ultraviolet light from sunshine may damage the coalescer and/or reduce the efficiency of the OWS.

15.1. REMOVING AND CLEANING 4-FOOT-DIAMETER OWS COALESCER

15.1.1. To remove a coalescer in a 4-foot-diameter OWS, follow this procedure (See FIGURE 15-1 and FIGURE 15-2):

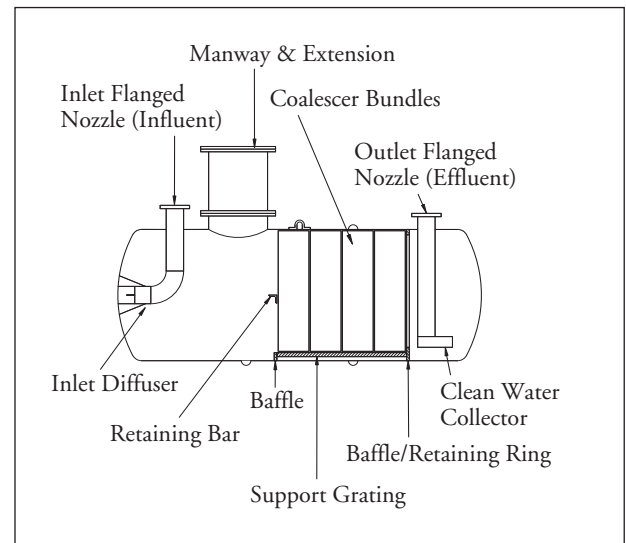

FIGURE 15-1

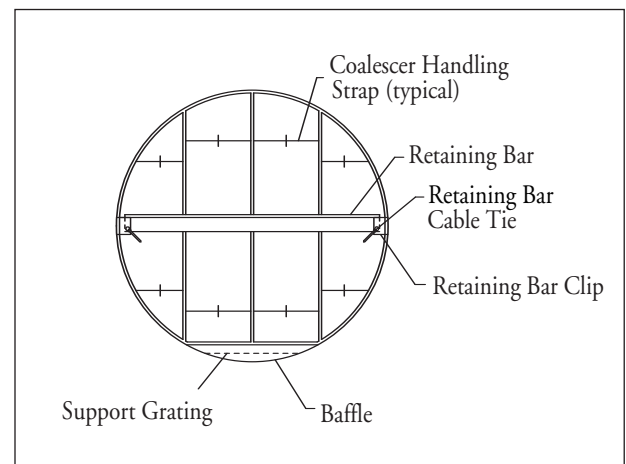

FIGURE 15-2

WARNING

Never enter the OWS, the riser, the manway extension or any other enclosed space without proper training and OSHA-approved equipment. See OSHA guidelines 29 CFR, Part 1910 "Permit Required Confined Spaces." Failure to follow this warning could result in death or serious injury.

15.1.1.1. From inside the OWS, lift up on the retaining bar to clear the clips and remove the bar.

15.1.1.2. Take hold of the coalescer handling straps on one of the center coalescer bundles and tilt the top of the bundle towards you.

15.1.1.3. Pull the bundle out of the pack and lift it through the manway.

15.1.1.4. Repeat Points 15.1.1.2. and 15.1.1.3. to remove the other center bundle.

15.1.1.5. Then, one at a time, slide each remaining bundle towards the center of the OWS.

15.1.1.6. Using the coalescer handling straps, lift each bundle through the manway, lifting high enough to clear the baffle.

15.1.1.7. Then, after that row is completely removed, remove the coalescer support grating section.

15.1.1.8. Depending on the OWS model, there can be several rows of bundles for each OWS. Repeat Points 15.1.1.2. through 15.1.1.7. until all bundles and support grating sections are removed.

CAUTION

Always remove coalescer packs using the handling straps. Never pull coalescer packs by individual tubes. Pulling coalescer packs by individual tubes may damage the coalescer packs and/or reduce the efficiency of the OWS.

15.2. REMOVING AND CLEANING 6-FOOT-DIAMETER OWS COALESCER

15.2.1. To remove a coalescer in a 6-foot-diameter OWS, follow this procedure (See FIGURE 15-3 and FIGURE 15-4.):

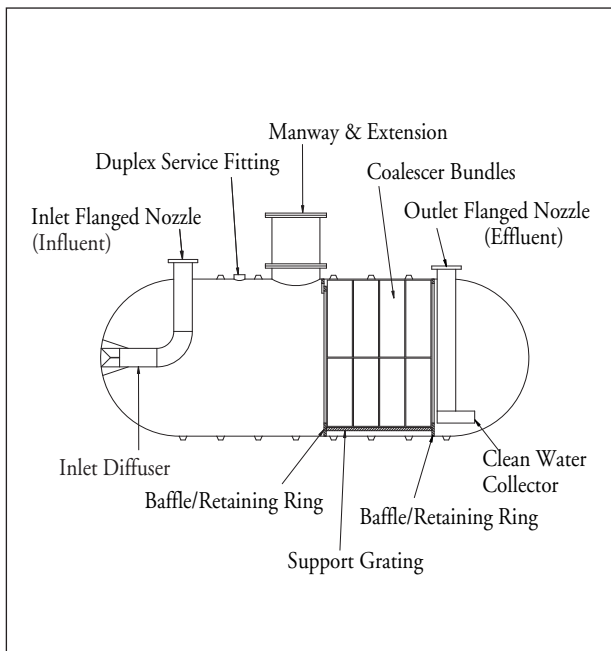

FIGURE 15-3

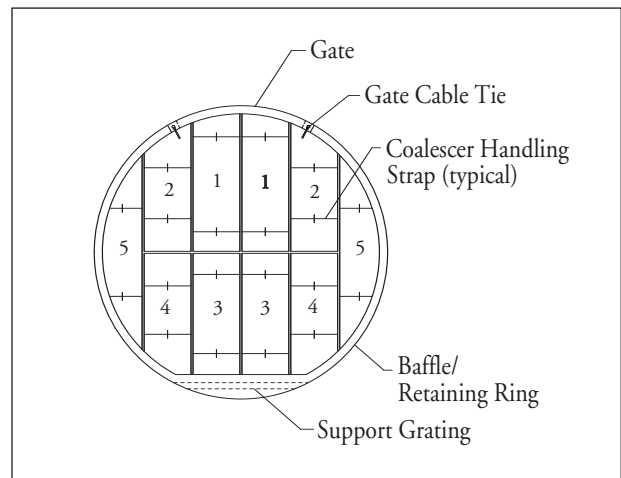

FIGURE 15-4

WARNING

Never enter the OWS, the riser, the manway extension or any other enclosed space without proper training and OSHA-approved equipment. See OSHA guidelines 29 CFR, Part 1910 "Permit Required Confined Spaces." Failure to follow this warning could result in death or serious injury.

15.2.1.1. From inside the OWS, remove the gate cable ties at the top of the retaining ring.

15.2.1.2. Remove the gate at the top of the OWS.

15.2.1.3. Take hold of the coalescer handling straps of one of the center coalescer bundles and pull it toward you.

15.2.1.4. Pull the bundle out of the pack and lift it through the manway.

15.2.1.5. Repeat Points 15.2.1.3. and 15.2.1.4. to remove the other center bundle.

15.2.1.6. Then, one at a time, slide each remaining bundle towards the center of the OWS.

15.2.1.7. Using the coalescer handling straps, lift each bundle through the manway, lifting high enough to clear the baffle.

15.2.1.8. Then, after that row is completely removed, remove the coalescer support grating section.

15.2.1.9. Depending on the OWS model, there can be up to five rows of bundles for each OWS. Repeat Points 15.2.1.3. through 15.2.1.8. until all bundles and support grating sections are removed.

15.3. REMOVING AND CLEANING 8-FOOT-DIAMETER OWS COALESCER AND 10-FOOT-DIAMETER OWS COALESCER

15.3.1. To remove a coalescer in an 8-foot- and 10-foot-diameter OWS, follow this procedure (See FIGURE 15-5 and FIGURE 15-6.):

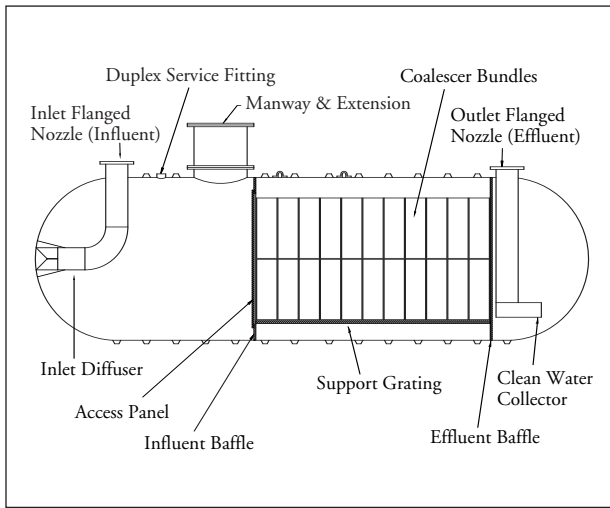

FIGURE 15-5

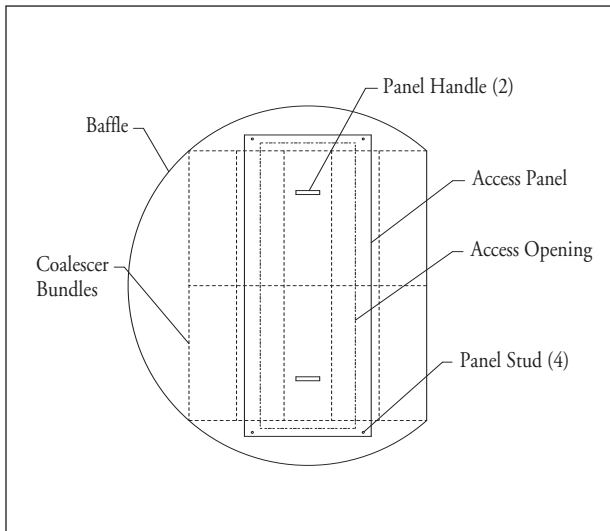

FIGURE 15-6

⚠ WARNING

Never enter the OWS, the riser, the manway extension or any other enclosed space without proper training and OSHA-approved equipment. See OSHA guidelines 29 CFR, Part 1910 "Permit Required Confined Spaces." Failure to follow this warning could result in death or serious injury.

15.3.1.1. From inside the OWS, remove the 4 retaining clips from the panel studs.

15.3.1.2. Remove the panel door.

15.3.1.3. Take hold of the coalescer handling straps of one center coalescer bundle and tilt the top toward the door.

15.3.1.4. Pull the bundle out of the pack and lift it through the manway.

15.3.1.5. Then, after each bundle is removed, remove the coalescer support grating section.

15.3.1.6. Depending on the OWS model, there can be several bundles for each OWS. Repeat Points 15.3.1.3. through 15.3.1.5. until all bundles and support grating sections are removed.

15.4. CLEANING THE COALESCER PACK

15.4.1. Use the following procedure to clean the coalescer pack:

15.4.1.1. Clean the coalescer pack in an area where the runoff from cleaning can be controlled.

⚠ WARNING

Discharge from cleaning the coalescers may have high concentrations of oil and other contaminants. Contact with skin or breathing in vapors could result in death or serious injury.

15.4.1.2. Dispose of oil from the OWS as required by federal, state and local regulations and codes.

15.4.1.3. Remove any large foreign objects stuck to the coalescer packs.

15.4.1.4. Wash the coalescer packs with a hose or pressure washer to remove accumulated oil and grit.

CAUTION

Do not use soaps or detergents when cleaning the coalescers. Soaps or detergents may damage the coalescers and/or reduce the efficiency of the OWS.

15.4.1.5. Remove the sludge from under the coalescer support grating in the coalescing chamber.

⚠ WARNING

OWS interior surfaces are slippery. A slip or fall could result in death or serious injury.

15.4.1.6. Replace the support grating, coalescer packs and retaining pieces. (When replacing the coalescer packs in the 6-foot-diameter OWS, use the numbers in FIGURE 15-4 as a guide for replacing same-size packs simultaneously.)

CAUTION

If the oil is not pumped out after reaching the level indicated in TABLE 13-1, and more oily water enters the OWS, the effluent oil concentration may exceed allowable levels. Excessive effluent oil concentration may damage and/or reduce the efficiency of the OWS.

16. HANDLING A MAJOR OIL SPILL

16.1. GENERAL

16.1.1. When the oil exceeds the nominal oil storage capacity of the OWS because of a spill, it may be considered a major oil spill. Take the following actions:

16.1.1.1. Notify the authorities required by applicable federal, state and local regulations and codes.

16.1.1.2. Pump out the oil in the OWS *by following instructions in SECTION 13*.

16.1.1.3. Charge the OWS with clean water.

16.1.1.4. Wait one hour for possible oil-level build-up that may release from the coalescer.

16.1.1.5. Check oil level again.

16.1.2. Repeat Points 16.1.1.2. and 16.1.1.3. if necessary to make sure all oil is removed from the OWS.

17. OPERATING GUIDELINES

17.1. GENERAL

17.1.1. See this manual and the Installation Manual for operating guidelines.

18. LIMITED WARRANTIES

18.1. GENERAL

18.1.1. Each product is covered by a product-specific limited warranty, which contain operating guidelines and parameters that should be reviewed as applicable. Copies of the limited warranties are found in Xerxes' product brochures and are available upon request from the UST coordinator at the plant nearest you.

19. SELECTED LIST OF SUPPLEMENTAL MATERIALS

19.1. GENERAL

19.1.1. See Installation Manual for list of supplemental materials.

20. RETAINING THE OWS MANUAL

20.1. GENERAL

20.1.1. After installation, tank installer must give OWS Manual and Installation Manual to OWS owner and operator.

20.1.2. After installation, tank owner must retain OWS Manual and Installation Manual for future reference to operating and maintenance guidelines.

Table 13-1
OWS Nominal Oil Storage Capacity
and Oil/Water Interface Levels

Nominal OWS Diameter (Feet)	Nominal OWS Capacity (Gallons)	Nominal Oil Storage Capacity (Gallons)	Oil Interface Level	
			Height from Bottom of OWS for Dipstick Monitoring	Depth from Top of OWS
4	600 SW	60	40"	7-3/4"
	700 DW	70	40"	7-3/4"
	1,000 SW/DW	103	40"	7-3/4"
6	2,000 SW	206	59-3/4"	11-3/8"
	3,000 DW	275	58-7/8"	11-3/8"
	4,000 SW	396	59-3/4"	11-3/8"
	4,000 DW	367	58-7/8"	11-3/8"
	6,000 SW	556	59-3/4"	11-3/8"
	6,000 DW	580	58-7/8"	11-3/8"
8	6,000 SW	584	76-1/4"	14-3/4"
	6,000 DW	576	75-1/2"	14-3/4"
	8,000 SW	774	76-1/4"	14-3/4"
	8,000 DW	771	75-1/2"	14-3/4"
	10,000 SW	970	76-1/4"	14-3/4"
	10,000 DW	966	75-1/2"	14-3/4"
	12,000 SW	1,166	76-1/4"	14-3/4"
	12,000 DW	1,161	75-1/2"	14-3/4"
10	12,000 SW	1,140	100"	19-3/8"
	12,000 DW	1,135	98-3/4"	19-3/8"
	15,000 SW	1,475	100"	19-3/8"
	15,000 DW	1,469	98-3/4"	19-3/8"
	20,000 SW	1,981	100"	19-3/8"
	20,000 DW	1,972	98-3/4"	19-3/8"
	25,000 SW	2,584	100"	19-3/8"
	25,000 DW	2,573	98-3/4"	19-3/8"
	30,000 SW	3,090	100"	19-3/8"
	30,000 DW	3,076	98-3/4"	19-3/8"

XERXES®

CORPORATION

7901 Xerxes Avenue South
Minneapolis, MN 55431-1288

Phone: (952) 887-1890

Fax: (952) 887-1870

www.xerxescorp.com



Manufacturing Facilities

Anaheim, California

Phone: (714) 630-0012

Fax: (714) 632-7133

Hagerstown, Maryland

Phone: (301) 223-6933

Fax: (301) 223-6836

Seguin, Texas

Phone: (830) 372-0090

Fax: (830) 372-0321

Tipton, Iowa

Phone: (563) 886-6172

Fax: (563) 886-2042