

# Installation Manual

---



**Oreco Systems®**  
Incorporated

814 AIRWAY AVENUE  
SUTHERLIN, OREGON  
97479-9012

TELEPHONE:  
(541) 459-4449

FACSIMILE:  
(541) 459-2884

## Most Versatile Panel MVP-DAX1 PT RO Manual# EIN-CP-DAX-514

### This Manual Contains:

Description	Document Number
1. Installation Instructions	EIN-CP-GEN-1
2. Panel Wiring Diagram	EDW-WD-DAX-82
3. Float Arrangement Diagram	EDW-FA-DAX-13
4. Float Arrangement Diagram	EDW-FA-DAX-14
5. MVP-DAX PT RO Operation	EIN-CP-OP-4
6. MVP-DAX PT RO Setting Instructions	EIN-CP-SET-9
7. MVP-Time & Date Setting Instructions	EIN-CP-SET-111

# Panel Installation

---



**Oreco Systems®**  
Incorporated

## Before Installing Panel

1. *Read all instructions before proceeding with the installation. Improper installation may void warranties.*
2. Inspect your order for completeness and inspect each component for shipment damage. If something is missing or damaged, you will need to contact your supplier to obtain replacements.
3. Check to be sure the instructions and items supplied comply with state and local regulations.
4. A qualified electrician must be employed to install and service the panel and ancillary wiring. The equipment must be installed in compliance with the National Electric Code, as well as state and local codes.

814 AIRWAY AVENUE  
SUTHERLIN, OREGON  
97479-9012

TELEPHONE:  
(541) 459-4449

FACSIMILE:  
(541) 459-2884

## Placement of the Control Panel

5. Install the electrical control or alarm panel within view of the tank. The panel should be attached to a post or an exterior wall. Panels that contain motor contactors make a thumping sound, each time a pump is started or stopped. Therefore, these panels should not be mounted to an exterior wall unless it is in a location away from living areas, such as on a garage wall. If possible, position the panel in the shade to protect it from weather. Extreme temperatures can cause inconsistent performance of the electrical components. Locate the panel at a convenient height (usually about five feet above the ground) and where it will be accessible for maintenance.

## Install Floats and Pumps

6. Install the electrical splice box(es) for the floats and pump(s) before installing the actual floats and pumping equipment. The splice box(es) are installed in the grommet(s) provided near the top of the riser.
7. Install the floats. Thread the float and pump cords through the cord grips into the PVC splice box, leaving adequate lengths of electrical cord coiled inside the riser to allow easy removal of the pump and float assembly. Do not remove the colored markers or the paper tags from the float cords, and do not try to thread the markers and tag through the cord grip. These should be left on the float cord, outside the splice box. Tighten the cord grips, using hand pressure or a wrench if necessary, until the cord will no longer move in the cord grip. If the cord grips are not tight enough, the seal will not be watertight, but overtightening may damage the cord or the cord grip, so use only as much force as necessary. Adequate lengths of cord should be left within the splice box to allow for easy removal for future disconnecting and re-splicing.
8. Run the wires from the control panel to the splice box. The wires can be brought through a conduit, or can be buried using suitable direct-burial wire. Conduit that enters the splice box must be sealed, even if the wires are direct-buried, to prevent the infiltration of water into the splice box. Use an electrically approved sealant to plug the wires coming in through the conduit hub. The number of wires required depends on the control panel and the number of floats and pumps used. This can be determined by consulting the Float Arrangement diagram appropriate for the control panel and float arrangement being used.

Wire should be sized at 14 AWG for the floats. Refer to Figure 1 to determine the proper size for the pump wires. When calculating wire size, the length and size of the branch circuit wires from the service entrance panel to the pump control panel must also be taken into account. Wire that's too small can cause an excessive voltage drop and poor pump performance.

Wires should be color coded or otherwise marked to aid in wiring the control panel. Drawing EIN-SB-SB-1 lists recommended colors for each of the wires. Colors may refer to either the color of the wire's insulation, the color of a tag, or the color of an electrical tape marker.

9. All splices made in the splice box should use waterproof wire nuts or butt connectors and heat shrink tubing. The splices must be waterproof! Splices that are not waterproof may cause a malfunction of the pump controls if water should leak into the splice box. Refer to Drawing EIN-SB-SB-1 for instructions on making waterproof splices. Refer to the appropriate Float Arrangement diagram for instructions on how to connect the floats together.

**Connect Control Panel**

10. Connect the wires coming from floats to the terminals in the control panel. Refer to the appropriate Float Arrangement diagram for the correct terminal connections.

11. Connect the wires coming from the pump(s) to the pump terminals. Refer to the panel wiring diagram for the correct terminal connections.

12. Connect the incoming power to the panel. Power to the panel must be appropriate to the control panel and pump motor (i.e. 120VAC, single phase for a 120 VAC motor, 240 VAC single phase for a 240 VAC motor, etc.) Insure that the panel is properly grounded and that the fuse or breaker and wire size, from the main power panel and to the pump, are sized correctly. Separate circuits for the pump controls and each of the pump motors is recommended. Note: Voltage for the controls in the panel is always 120VAC, although the pump voltage may be 120VAC or 240 VAC.

13. Use 60° minimum CU conductors only. Torque the terminal blocks to 15 LB-IN and the ground lugs to 45 LB-IN. Torque the circuit breakers to 20 LB-IN for 14-10 AWG wire, 25 LB-IN for 8 AWG wire, and 27 LB-IN for 6-4 AWG wire.

14. When power is applied to the control panel, the wires to the pump may be energized. Do not service the pump or any electrical wiring in the pump vault without disconnecting the power at the circuit breaker and the fuse. The pump vault area is a hazardous area, and may contain explosive gases. Take appropriate precautions before working in the pump vault.

15. If you have any questions please contact Orenco Systems, Inc.

**Figure 1. Recommended Breaker & Wire Size**

<u>Pump Motor Size</u>	<u>Breaker size</u>	<u>Wire Size</u>	<u>Max Distance*</u>
120 VAC 1/2 hp	20 amp	10 AWG	105 ft
240 VAC 1/2 hp	15 amp	14 AWG	161 ft
3/4 hp	20 amp	14 AWG	130 ft
1 hp	20 amp	12 AWG	172 ft
1 1/2 hp	20 amp	12 AWG	126 ft

\* This is the maximum distance from this subpanel to the pump motor for the recommended wire size. Distance is based on 3% maximum voltage drop from subpanel to load at maximum recognized pump motor amps at 75° C.

# Panel Wiring Diagram Model MVP-DAX1 PTR0



814 AIRWAY AVENUE  
SUTHERLIN, OREGON  
97479-9012

TELEPHONE:  
(541) 459-4449

FACSIMILE:  
(541) 459-2884

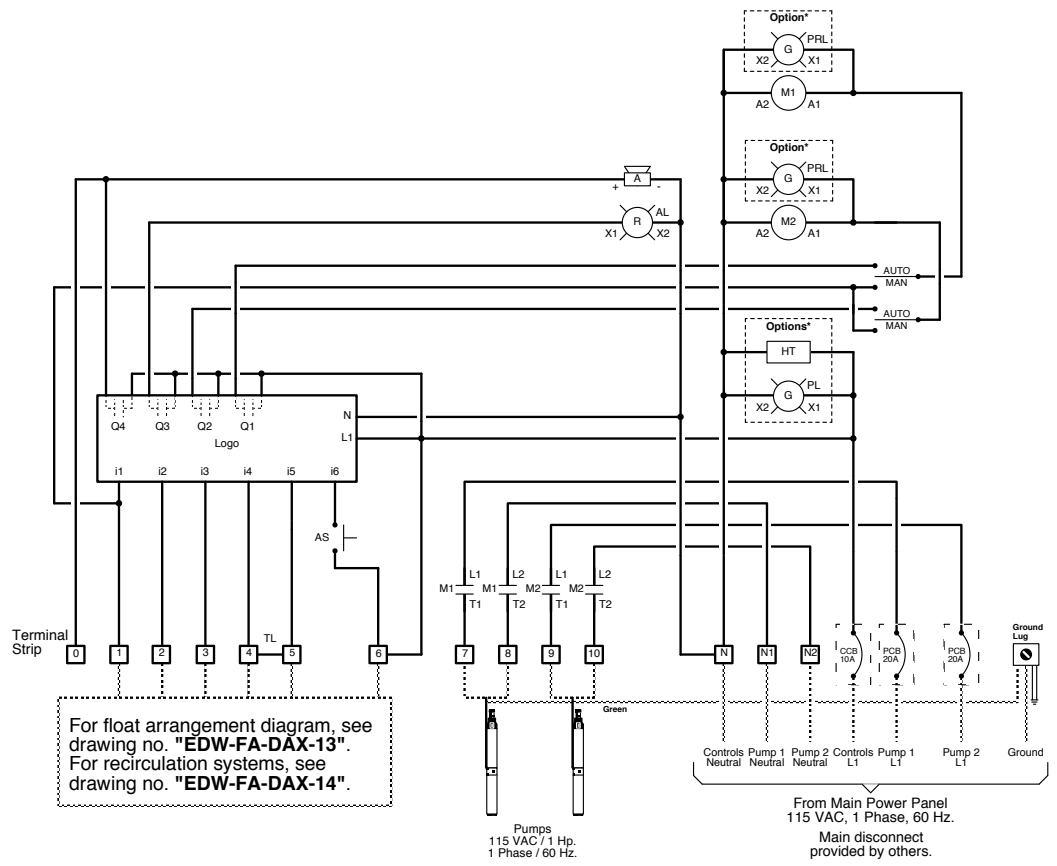

For float arrangement diagram, see drawing no. "EDW-FA-DAX-13".  
For recirculation systems, see drawing no. "EDW-FA-DAX-14".

NOTE: Motors must have internal overload protection

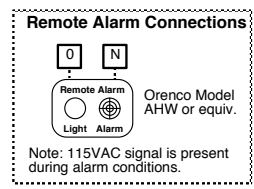
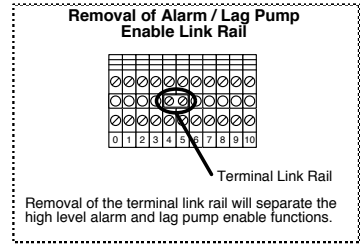

- Key**
- = Factory Wire
  - - - = Field Wire
  - · - = Alternate Field Wire
  - A = Audio Alarm, 115 VAC
  - AL = Alarm Light
  - AS = Audio Silence Switch
  - CCB = Controls Circuit Breaker
  - Logo = Logic Module
  - M = Motor Contactor
  - PCB = Pump Circuit Breaker
  - TL = Terminal Link
- \*Options**
- HT = Heater
  - PL = Power Light
  - PRL = Pump Run Light

For MVP-DAX operation description, see drawing no. "EIN-CP-OP-4".

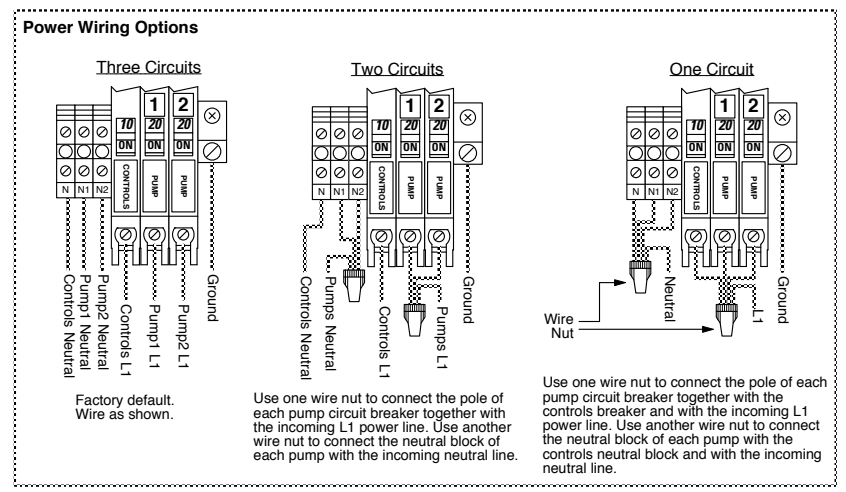

# Float Arrangement Diagram

Check the appropriate box for the float function (color code) used in your system.



**Oreco Systems®**  
Incorporated

814 AIRWAY AVENUE  
SUTHERLIN, OREGON  
97479-9012

TELEPHONE:  
(541) 459-4449

FACSIMILE:  
(541) 459-2884

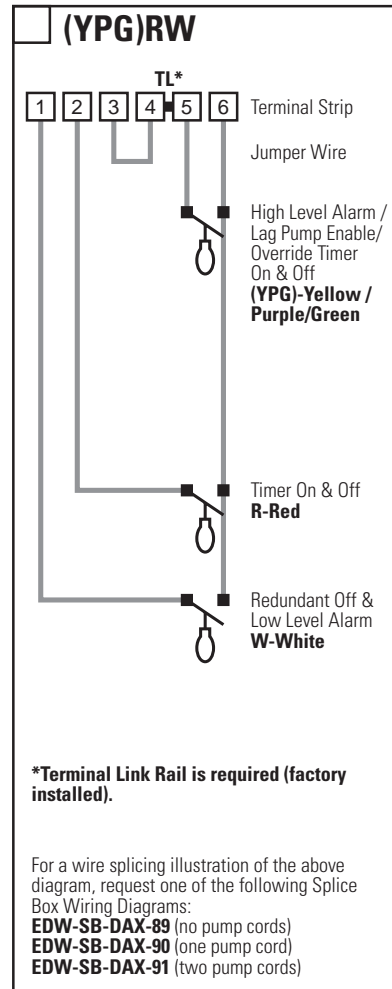
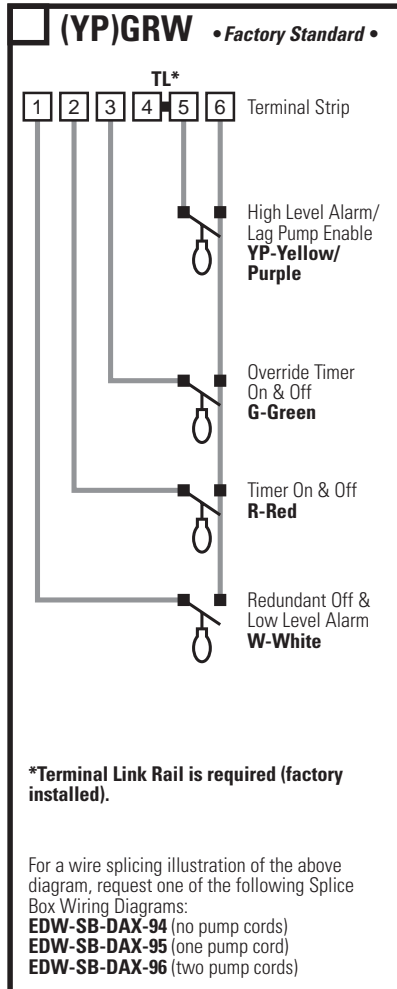

## Float Types

- **Typical Oreco float model:** A
- **Specs:** contact - normally open differential - no minimum power rating - signal
- **Possible substitutions:** B, C, D

Control Panel Series

**MVP-DAX PT RO**

Drawing No.

**EDW-FA-DAX-13**

EDW-FA-DAX-13  
Rev 2.5 © 11/09/05

# Splice Box Wiring Diagram



Oreco Systems®  
Incorporated

814 AIRWAY AVENUE

SUTHERLIN, OREGON

97479-9012

TELEPHONE:



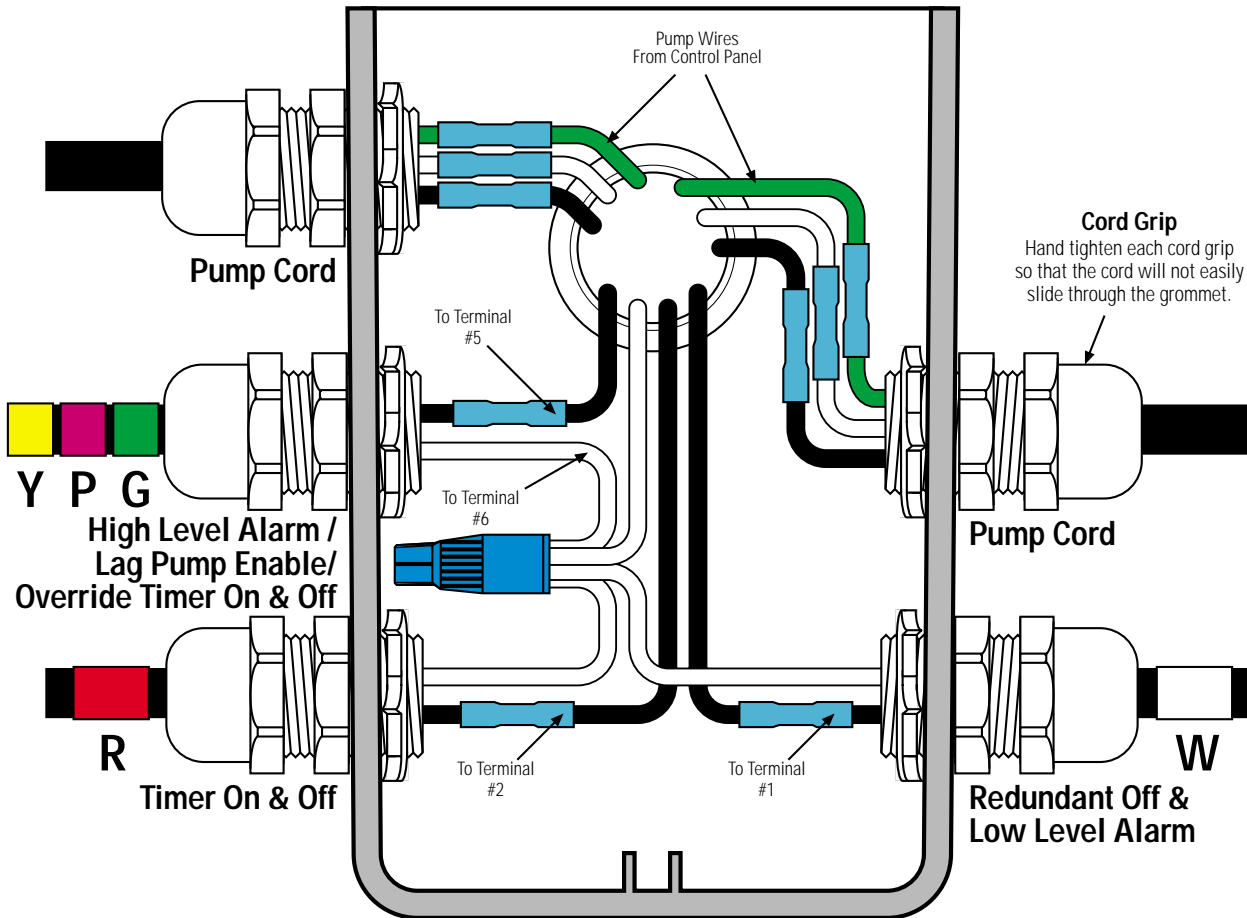

(541) 459-4449

FACSIMILE:

(541) 459-2884

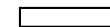

## Key

-  Black Wire
-  White Wire
-  Green Wire
-  Waterproof Wire Nut
-  Heat Shrink & Butt Connector \*

\* Refer to drawing EIN-SB-SB-1 for splicing instructions.

## Float Tag Colors

- Y** - Yellow
- P** - Purple
- B** - Blue
- G** - Green
- R** - Red
- O** - Orange
- E** - Grey
- W** - White

Note: Multi-function floats will have more than one marker

**Attention:** Failure to follow splicing instructions will void warranty

Control Panel Series

**MVP-DAX**

Float Function Color Code

**(YPG)RW**

Splice Box Model

**SB5**

Drawing No.

**EDW-SB-DAX-91**

EDW-SB-DAX-91  
Rev 1.1 ©04/21/99

# Splice Box Wiring Diagram



Oreco Systems®  
Incorporated

814 AIRWAY AVENUE

SUTHERLIN, OREGON

97479-9012

TELEPHONE:



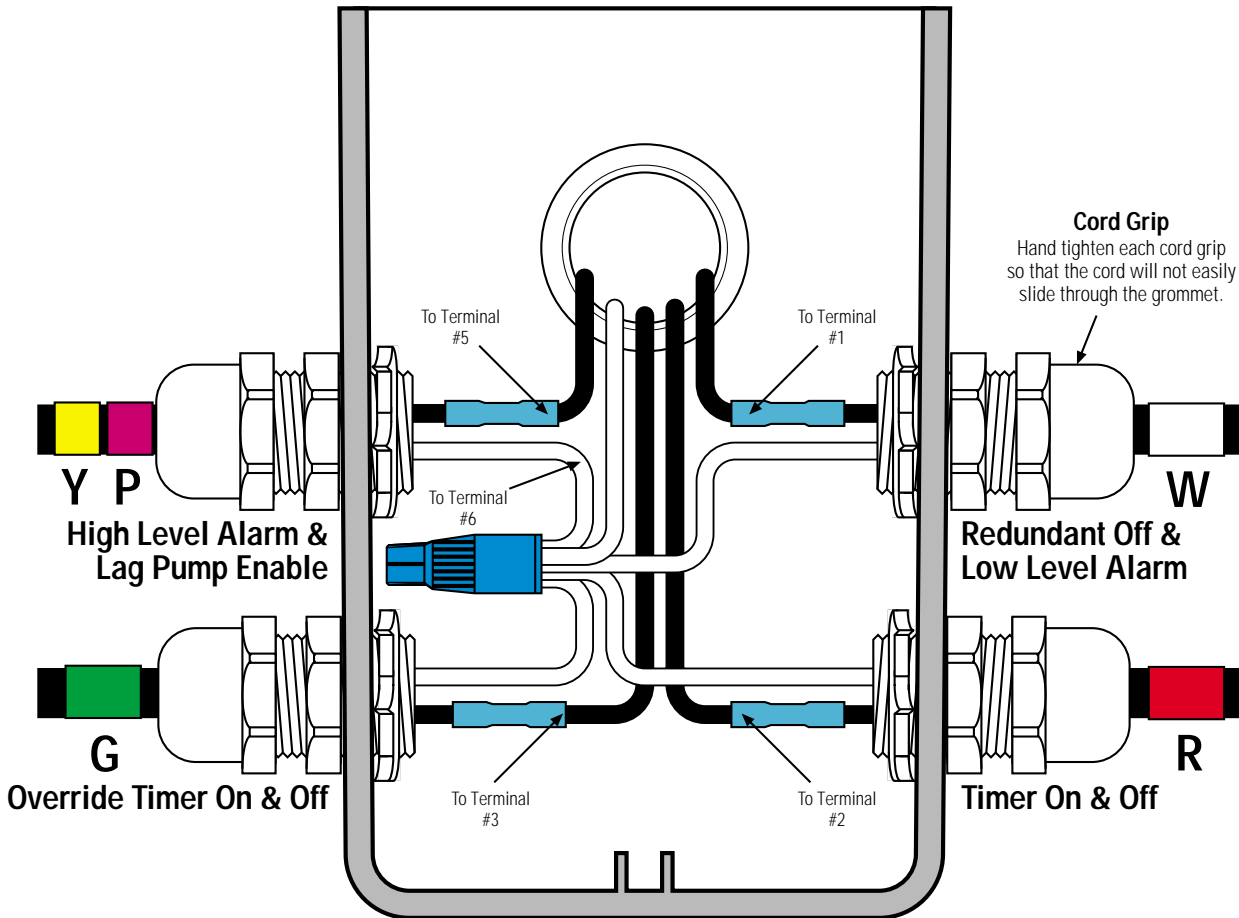

(541) 459-4449

FACSIMILE:

(541) 459-2884

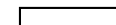

## Key

-  Black Wire
-  White Wire
-  Green Wire
-  Waterproof Wire Nut
-  Heat Shrink & Butt Connector \*

\* Refer to drawing EIN-SB-SB-1 for splicing instructions.

## Float Tag Colors

- Y** - Yellow
- P** - Purple
- B** - Blue
- G** - Green
- R** - Red
- O** - Orange
- E** - Grey
- W** - White

Note: Multi-function floats will have more than one marker

**Attention:** Failure to follow splicing instructions will void warranty

Control Panel Series

**MVP-DAX**

Float Function Color Code

**(YP)GRW**

Splice Box Model

**SB4**

Drawing No.



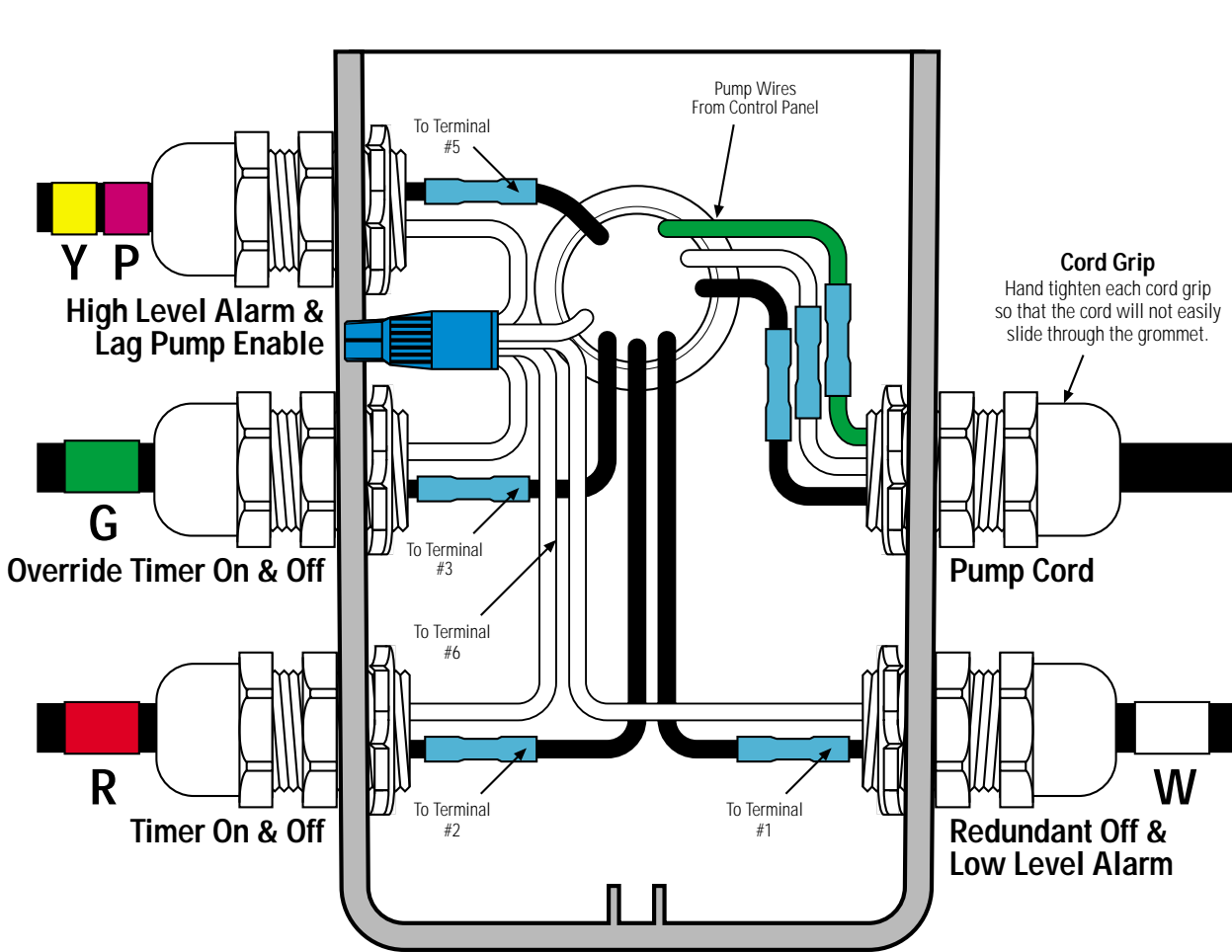

**EDW-SB-DAX-94**

EDW-SB-DAX-94  
Rev 1.0 ©04/21/99

# Splice Box Wiring Diagram



## Key

-  Black Wire
-  White Wire
-  Green Wire
-  Waterproof Wire Nut
-  Heat Shrink & Butt Connector \*

\* Refer to drawing EIN-SB-SB-1 for splicing instructions.

## Float Tag Colors

- Y** - Yellow
- P** - Purple
- B** - Blue
- G** - Green
- R** - Red
- O** - Orange
- E** - Grey
- W** - White

Note: Multi-function floats will have more than one marker

**Attention:** Failure to follow splicing instructions will void warranty

Control Panel Series

**MVP-DAX**

Float Function Color Code

**(YP)GRW**

Splice Box Model

**SB5**

Drawing No.

**EDW-SB-DAX-95**



# Splice Box Wiring Diagram



Oreco Systems®  
Incorporated

814 AIRWAY AVENUE

SUTHERLIN, OREGON

97479-9012

TELEPHONE:



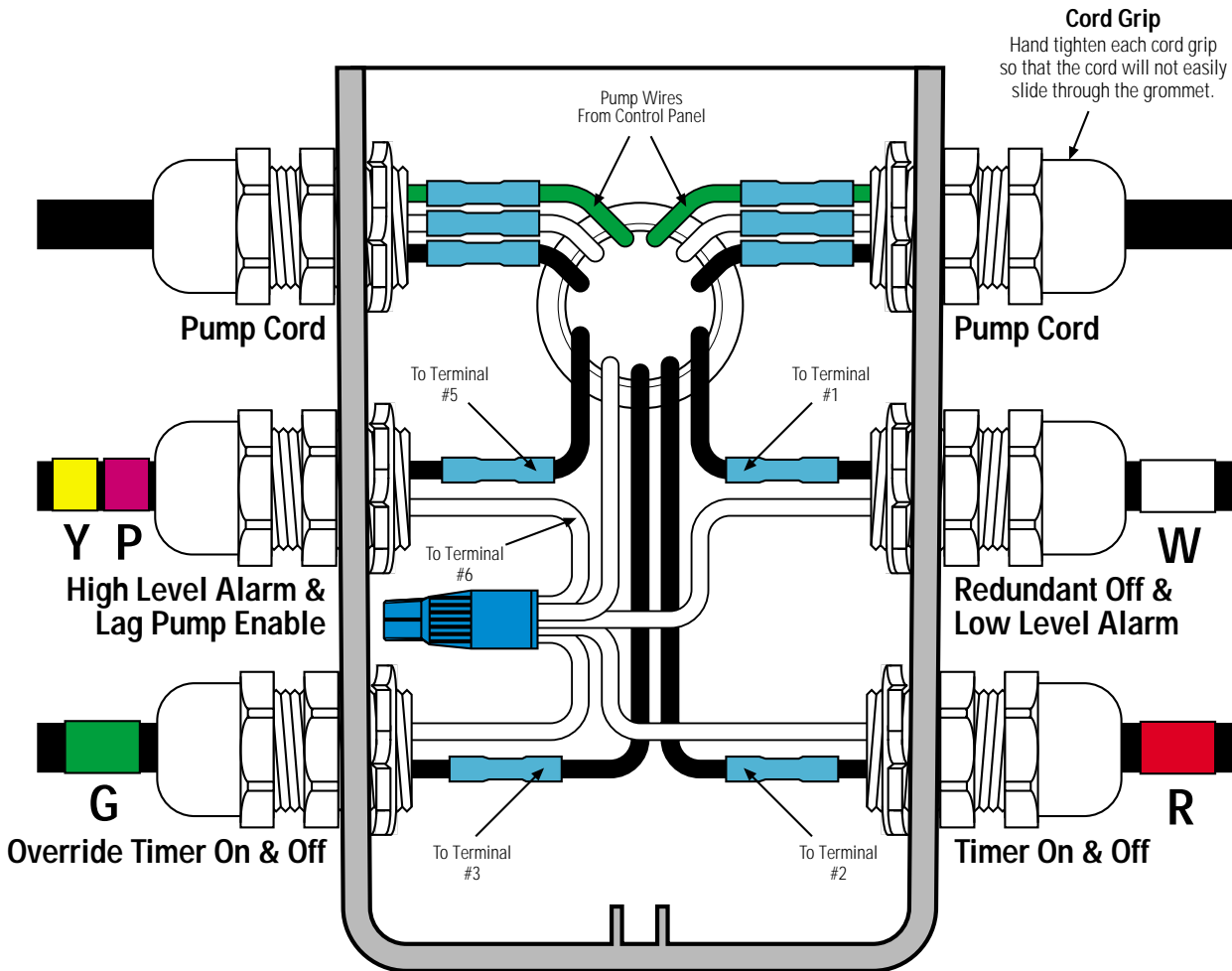

(541) 459-4449

FACSIMILE:

(541) 459-2884

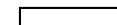

## Key

-  Black Wire
-  White Wire
-  Green Wire
-  Waterproof Wire Nut
-  Heat Shrink & Butt Connector \*

\* Refer to drawing EIN-SB-SB-1 for splicing instructions.

## Float Tag Colors

- Y** - Yellow
- P** - Purple
- B** - Blue
- G** - Green
- R** - Red
- O** - Orange
- E** - Grey
- W** - White

Note: Multi-function floats will have more than one marker

**Attention:** Failure to follow splicing instructions will void warranty

Control Panel Series

**MVP-DAX**

Float Function Color Code

**(YP)GRW**

Splice Box Model

**SB6**

Drawing No.

**EDW-SB-DAX-96**

EDW-SB-DAX-96  
Rev 1.0 ©04/20/99

# Splice Box Wiring Diagram



**Oreco Systems®**  
Incorporated

814 AIRWAY AVENUE

SUTHERLIN, OREGON

97479-9012

TELEPHONE:



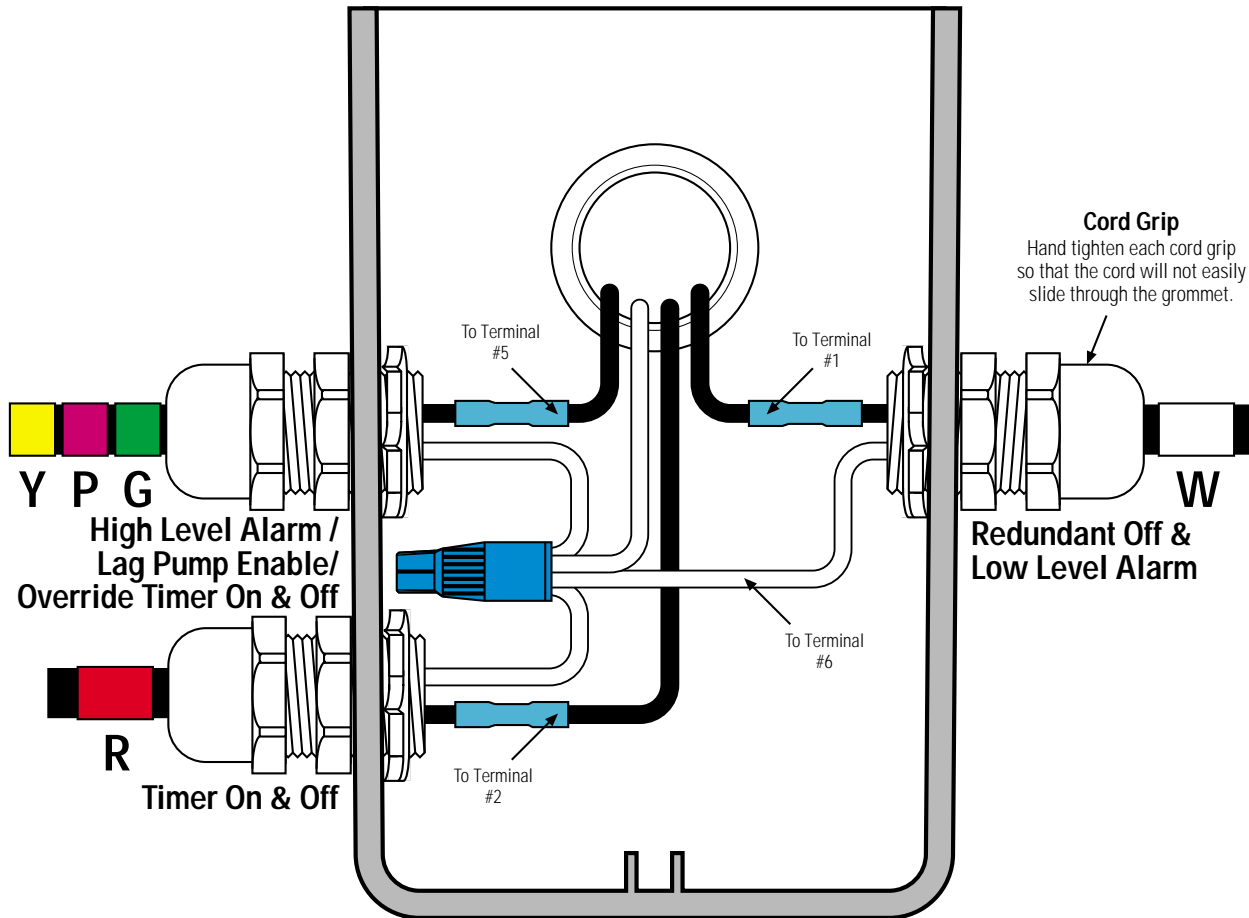

(541) 459-4449

FACSIMILE:

(541) 459-2884



## Key

-  Black Wire
-  White Wire
-  Green Wire
-  Waterproof Wire Nut
-  Heat Shrink & Butt Connector \*

\* Refer to drawing EIN-SB-SB-1 for splicing instructions.

## Float Tag Colors

- Y** - Yellow
- P** - Purple
- B** - Blue
- G** - Green
- R** - Red
- O** - Orange
- E** - Grey
- W** - White

Note: Multi-function floats will have more than one marker

**Attention:** Failure to follow splicing instructions will void warranty

Control Panel Series

**MVP-DAX**

Float Function Color Code

**(YPG)RW**

Splice Box Model

**SB3**

Drawing No.

**EDW-SB-DAX-89**

EDW-SB-DAX-89  
Rev 1.1 ©04/21/99

# Splice Box Wiring Diagram



**Oreco Systems®**  
Incorporated

814 AIRWAY AVENUE

SUTHERLIN, OREGON

97479-9012

TELEPHONE:



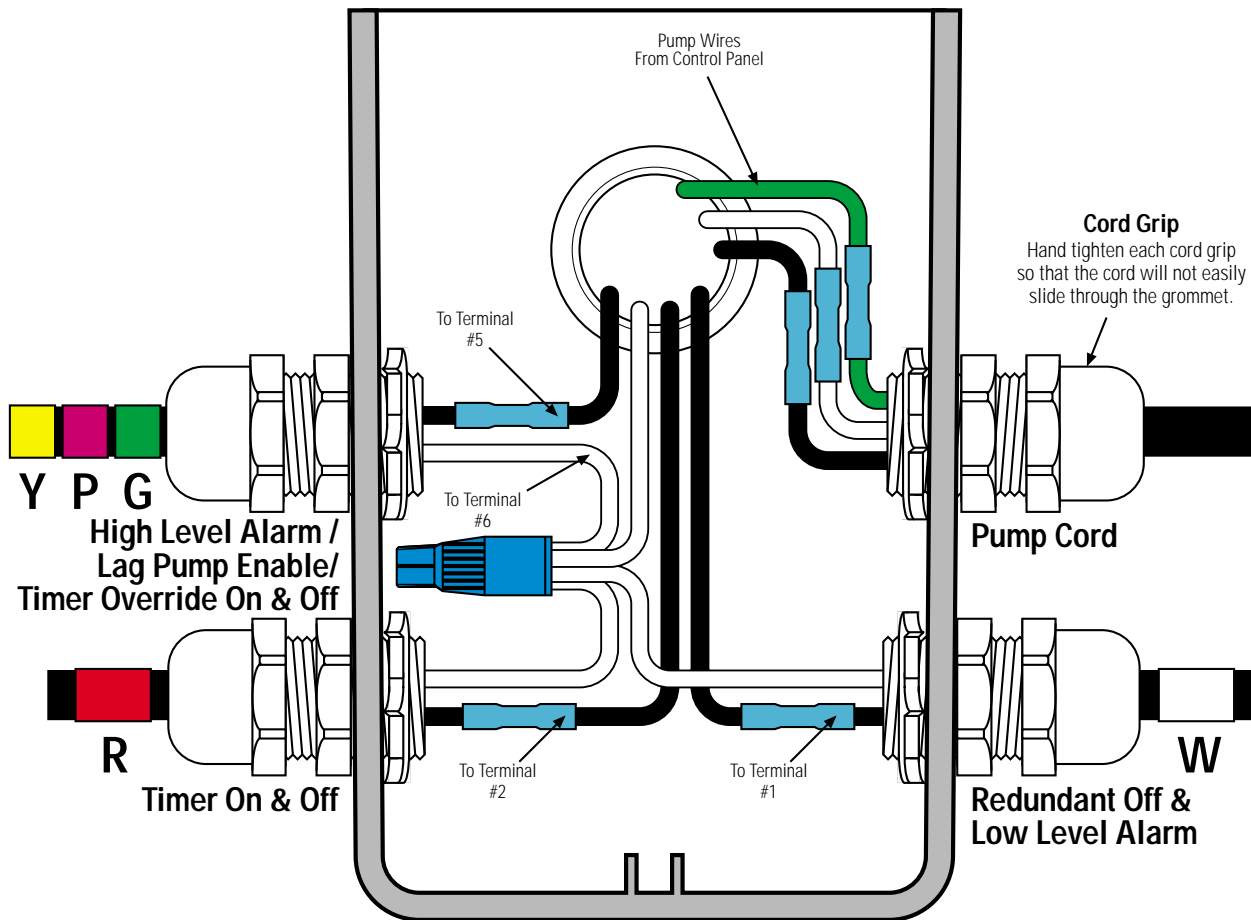

(541) 459-4449

FACSIMILE:

(541) 459-2884



## Key

-  Black Wire
-  White Wire
-  Green Wire
-  Waterproof Wire Nut
-  Heat Shrink & Butt Connector \*

\* Refer to drawing EIN-SB-SB-1 for splicing instructions.

## Float Tag Colors

- Y** - Yellow
- P** - Purple
- B** - Blue
- G** - Green
- R** - Red
- O** - Orange
- E** - Grey
- W** - White

Note: Multi-function floats will have more than one marker

**Attention:** Failure to follow splicing instructions will void warranty

Control Panel Series

**MVP-DAX**

Float Function Color Code

**(YPG)RW**

Splice Box Model

**SB4**

Drawing No.

**EDW-SB-DAX-90**

EDW-SB-DAX-90  
Rev 1.1 ©04/21/99

# Float Arrangement Diagram



**Oreco Systems®**  
Incorporated

Check the appropriate box for the float function (color code) used in your system.

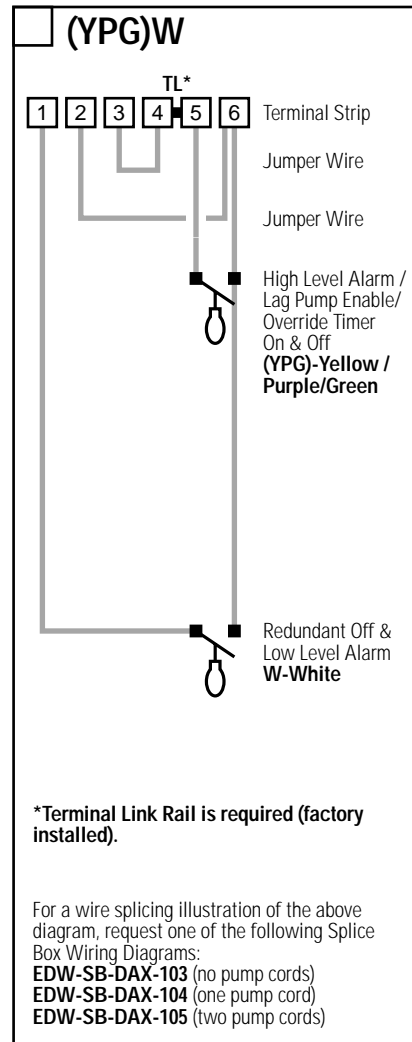
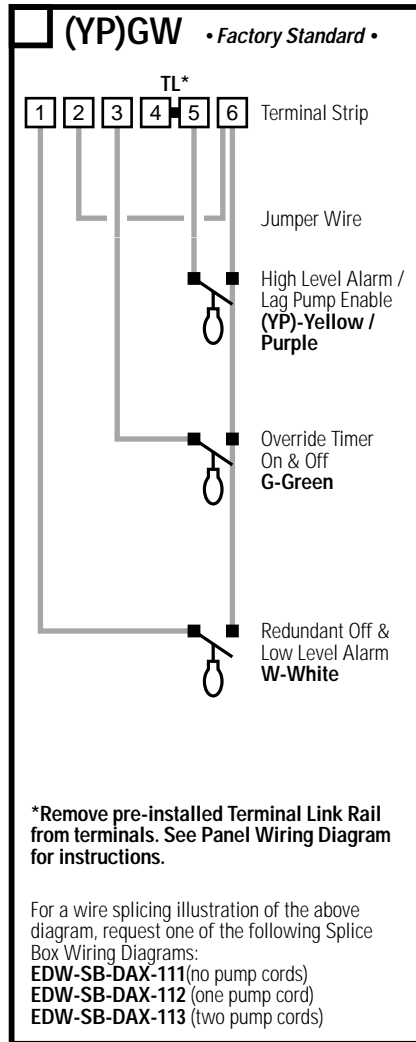

**Float Types**

■ **Typical OSI float model: A**  
**Specs:** contact - normally open  
differential - no minimum  
power rating - signal  
**Possible substitutions:** B,C,D

814 AIRWAY AVENUE  
SUTHERLIN, OREGON  
97479-9012

TELEPHONE:  
(541) 459-4449

FACSIMILE:  
(541) 459-2884

Control Panel Series

**MVP-DAX PT RO**

For use in recirculating systems.

Drawing No.

**EDW-FA-DAX-14**

EDW-FA-DAX-14  
Rev 2.4 ©01/14/99

# Splice Box Wiring Diagram



Oreco Systems®  
Incorporated

814 AIRWAY AVENUE

SUTHERLIN, OREGON

97479-9012

TELEPHONE:



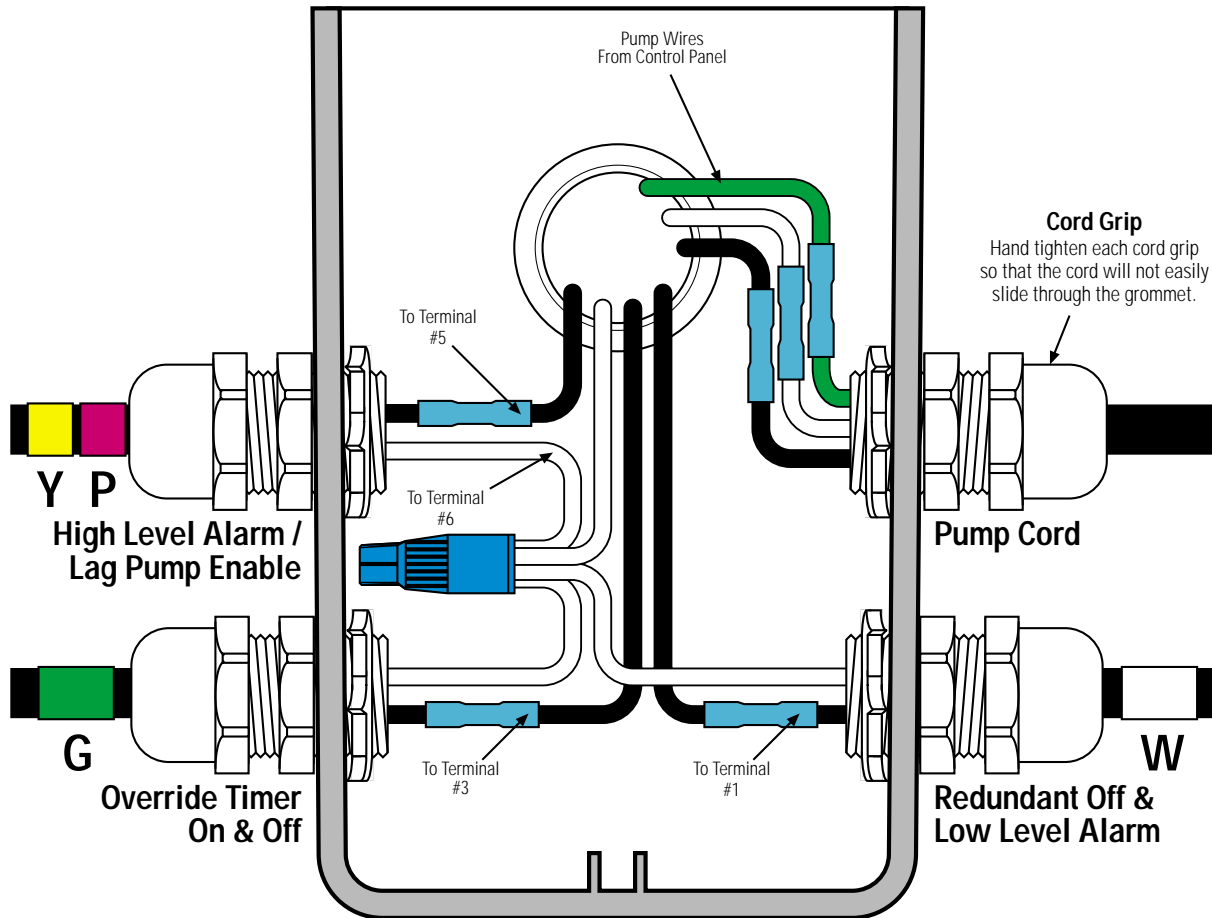

(541) 459-4449

FACSIMILE:

(541) 459-2884

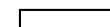

## Key

-  Black Wire
-  White Wire
-  Green Wire
-  Waterproof Wire Nut
-  Heat Shrink & Butt Connector \*

\* Refer to drawing EIN-SB-SB-1 for splicing instructions.

## Float Tag Colors

- Y** - Yellow
- P** - Purple
- B** - Blue
- G** - Green
- R** - Red
- O** - Orange
- E** - Grey
- W** - White

Note: Multi-function floats will have more than one marker

**Attention:** Failure to follow splicing instructions will void warranty

Control Panel Series

MVP-DAX

Float Function Color Code

(YP)GW

Splice Box Model

SB4

Drawing No.

EDW-SB-DAX-112

EDW-SB-DAX-112  
Rev 1.0 © 12/04/98

# Splice Box Wiring Diagram



**Oreco Systems®**  
Incorporated

814 AIRWAY AVENUE

SUTHERLIN, OREGON

97479-9012

TELEPHONE:



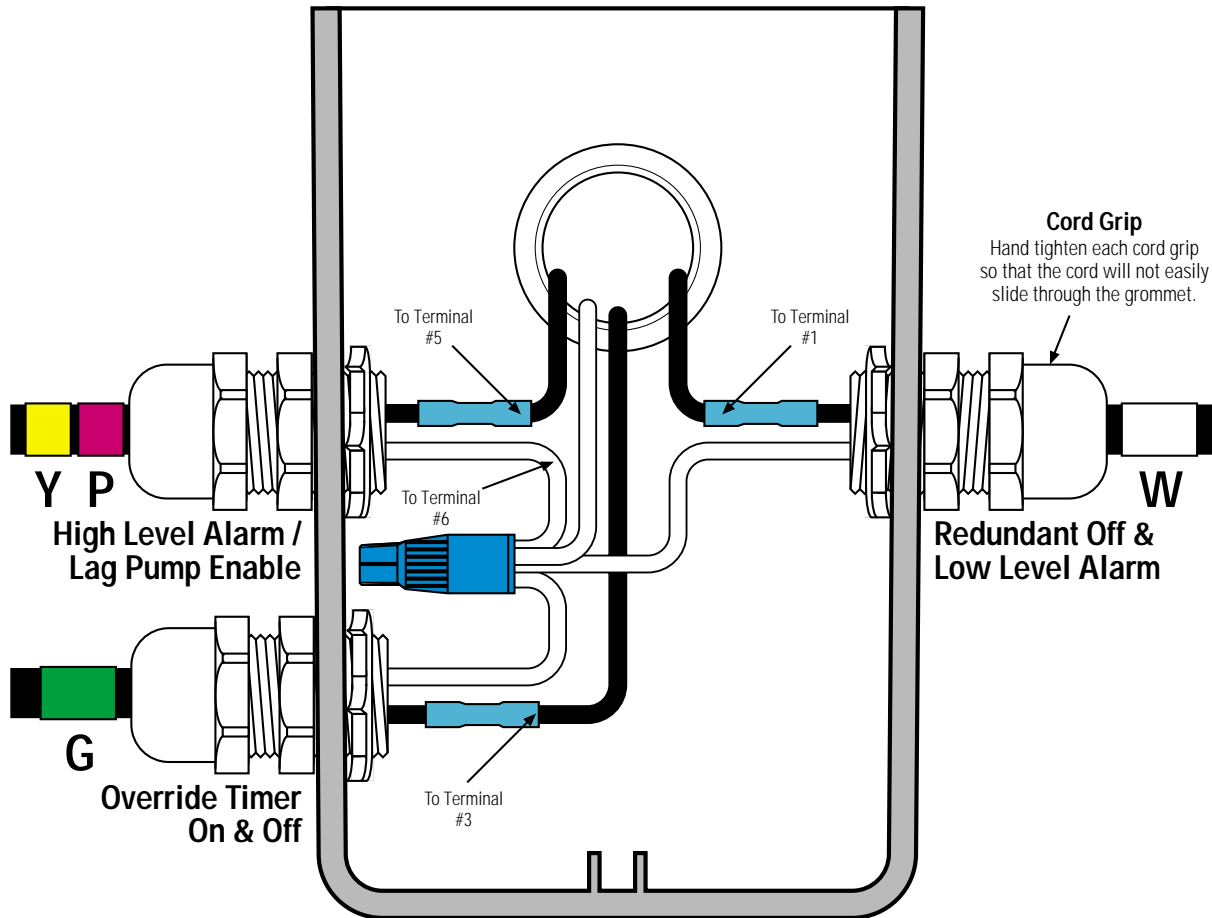

(541) 459-4449

FACSIMILE:

(541) 459-2884

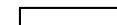

## Key

-  Black Wire
-  White Wire
-  Green Wire
-  Waterproof Wire Nut
-  Heat Shrink & Butt Connector \*

\* Refer to drawing EIN-SB-SB-1 for splicing instructions.

## Float Tag Colors

- Y** - Yellow
- P** - Purple
- B** - Blue
- G** - Green
- R** - Red
- O** - Orange
- E** - Grey
- W** - White

Note: Multi-function floats will have more than one marker

**Attention:** Failure to follow splicing instructions will void warranty

Control Panel Series

**MVP-DAX**

Float Function Color Code

**(YP)GW**

Splice Box Model

**SB3**

Drawing No.

**EDW-SB-DAX-111**

EDW-SB-DAX-111  
Rev 1.0 © 12/04/98

# Splice Box Wiring Diagram



**Oreco Systems®**  
Incorporated

814 AIRWAY AVENUE

SUTHERLIN, OREGON

97479-9012

TELEPHONE:



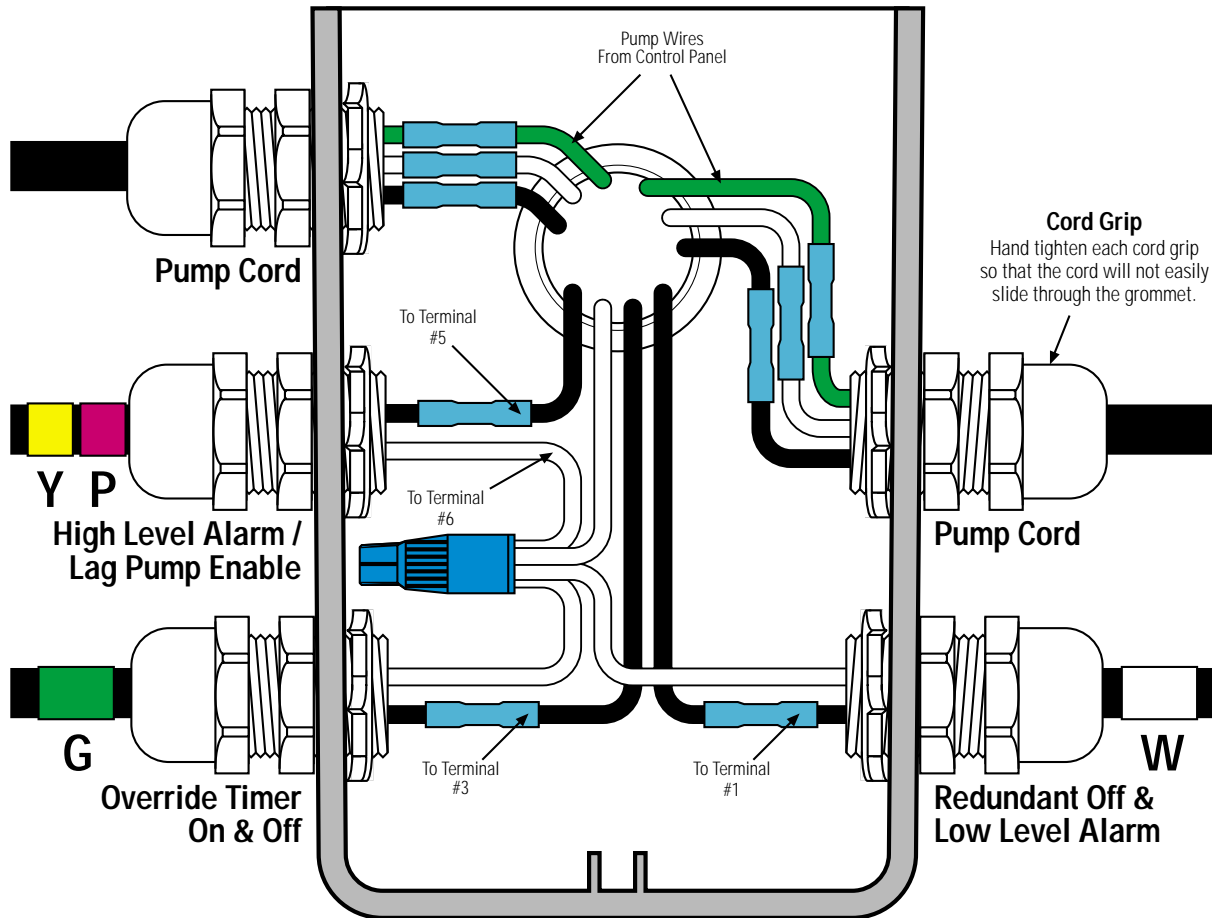

(541) 459-4449

FACSIMILE:

(541) 459-2884

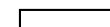

## Key

-  Black Wire
-  White Wire
-  Green Wire
-  Waterproof Wire Nut
-  Heat Shrink & Butt Connector \*

\* Refer to drawing EIN-SB-SB-1 for splicing instructions.

## Float Tag Colors

- Y** - Yellow
- P** - Purple
- B** - Blue
- G** - Green
- R** - Red
- O** - Orange
- E** - Grey
- W** - White

Note: Multi-function floats will have more than one marker

**Attention:** Failure to follow splicing instructions will void warranty

Control Panel Series

**MVP-DAX**

Float Function Color Code

**(YP)GW**

Splice Box Model

**SB5**

Drawing No.

**EDW-SB-DAX-113**

EDW-SB-DAX-113  
Rev 1.0 © 12/04/98

# MVP - Control Panel Instructions

## Contrast Adjustment and Time & Date Settings



**Oreco Systems®**  
Incorporated

814 AIRWAY AVENUE  
SUTHERLIN, OREGON  
97479-9012

TELEPHONE:  
(541) 459-4449

FACSIMILE:  
(541) 459-2884

Oreco's Most Versatile Panel (MVP) line of control panels includes an easy-to-use programmable logic unit that incorporates many timing and logic functions. The readability of the display may vary with temperature and ambient light. If the screen is difficult to read, adjusting the contrast is recommended. Instructions for adjusting the contrast are shown below. Setting the date and time is typically not necessary. However, if required, the time and date can be set by following instructions shown below.

To adjust the settings, use the four arrow keys located on the face of the unit (up, down, left, and right), along with the "ESC" key and the "OK" key. Follow the steps, below:

### Changing Settings:

Step 1: Press **▼** repeatedly until the display does not change. To begin the configuration process, press the "ESC" key.

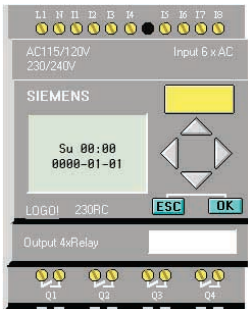

Step 2: Select "Set..." (Press **▲** or **▼**), and then press the "OK" key.

**Warning: Do not select "Stop". Doing so may erase the panel programming, which can not be restored without the use of an EEPROM card, which is not included with the panel. If this is selected by accident, a confirmation screen will come up. Select "No" and press the "OK" key immediately.**

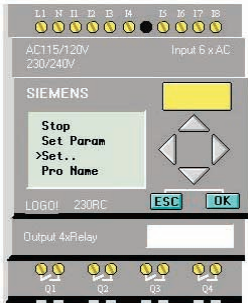

If adjusting contrast, continue with the steps below. If adjusting time & date, skip to "Setting Time and Date:" on next page.

### Adjusting Contrast:

Step 3: Select "Contrast" (Press **▲** or **▼**), and then press the "OK" key.

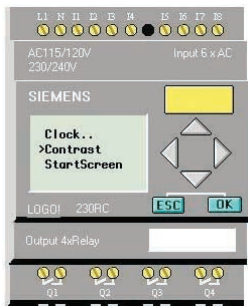

Step 4: Select the desired contrast (Press **◀** or **▶**), and then press the "OK" key.

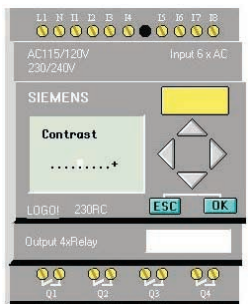



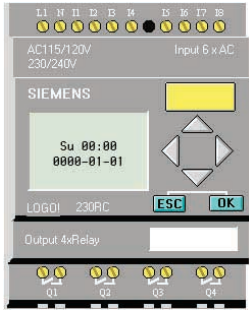

Step 5: To exit, press the “ESC” key once.

### Setting Time and Date:

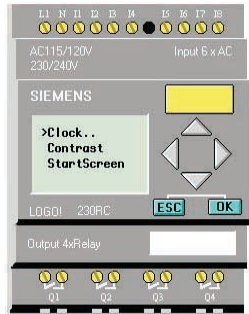

Step 3: Select “Clock...” (Press ▲ or ▼), and then press the “OK” key.

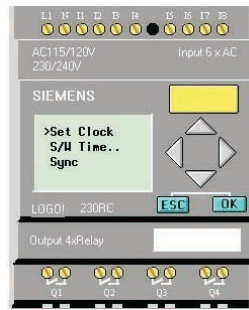

Step 4: Select “Set Clock” (Press ▲ or ▼), and then press the “OK” key.

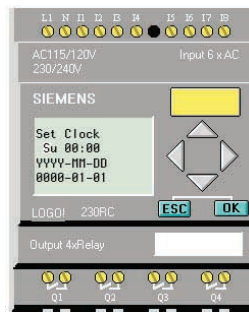

Step 5: Move the cursor to the desired position by pressing ◀ or ▶.

Step 6: Change the value by pressing ▲ or ▼.

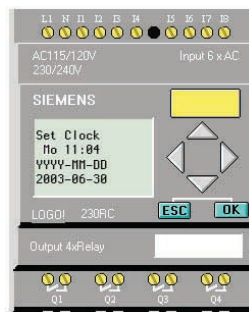

Step 7: To confirm your entries press the “OK” key once. Then, press the “ESC” key twice.

# Splice Box Wiring Diagram

For use in recirculating systems.



**Oreco Systems®**  
Incorporated

814 AIRWAY AVENUE

SUTHERLIN, OREGON

97479-9012

TELEPHONE:



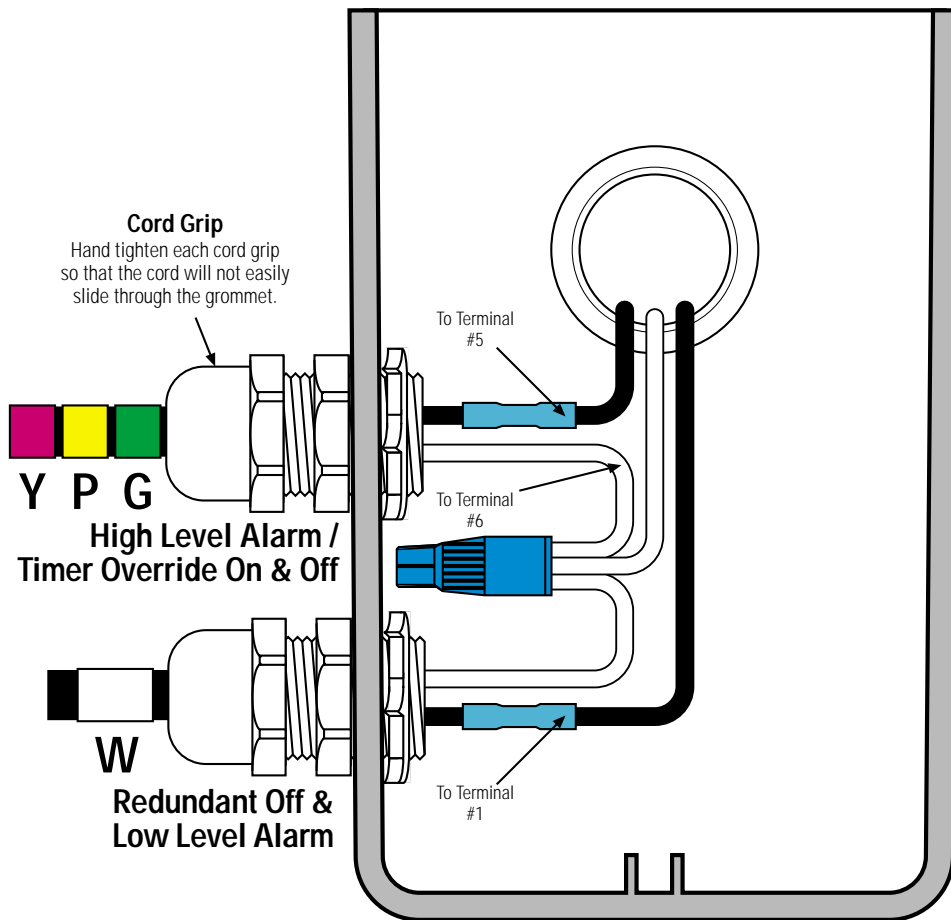

(541) 459-4449

FACSIMILE:

(541) 459-2884

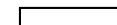

## Key

-  Black Wire
-  White Wire
-  Green Wire
-  Waterproof Wire Nut
-  Heat Shrink & Butt Connector \*

\* Refer to drawing EIN-SB-SB-1 for splicing instructions.

## Float Tag Colors

- Y** - Yellow
- P** - Purple
- B** - Blue
- G** - Green
- R** - Red
- O** - Orange
- E** - Grey
- W** - White

Note: Multi-function floats will have more than one marker

**Attention:** Failure to follow splicing instructions will void warranty

Control Panel Series

**MVP-DAX**

Float Function Color Code

**(YPG)W**

Splice Box Model

**SB2**

Drawing No.

**EDW-SB-DAX-103**

EDW-SB-DAX-103  
Rev 1.0 © 12/04/98

# Splice Box Wiring Diagram

For use in recirculating systems.



**Oreco Systems**  
Incorporated

814 AIRWAY AVENUE

SUTHERLIN, OREGON

97479-9012

TELEPHONE:



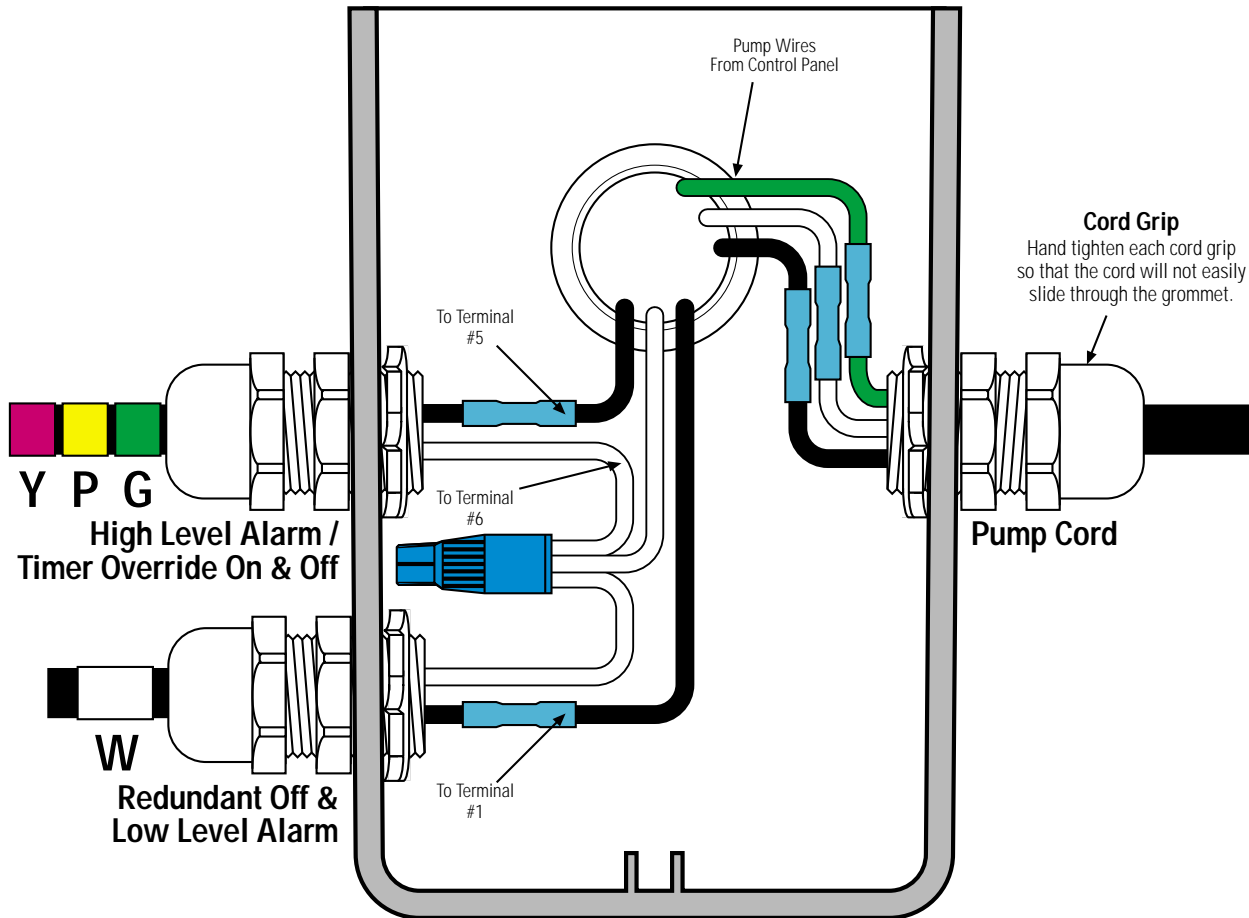

(541) 459-4449

FACSIMILE:

(541) 459-2884

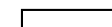

## Key

-  Black Wire
-  White Wire
-  Green Wire
-  Waterproof Wire Nut
-  Heat Shrink & Butt Connector \*

\* Refer to drawing EIN-SB-SB-1 for splicing instructions.

## Float Tag Colors

- Y** - Yellow
- P** - Purple
- B** - Blue
- G** - Green
- R** - Red
- O** - Orange
- E** - Grey
- W** - White

Note: Multi-function floats will have more than one marker

**Attention:** Failure to follow splicing instructions will void warranty

Control Panel Series

**MVP-DAX**

Float Function Color Code

**(YPG)W**

Splice Box Model

**SB3**

Drawing No.

**EDW-SB-DAX-104**

EDW-SB-DAX-104  
Rev 1.0 © 12/04/98

# Splice Box Wiring Diagram

For use in recirculating systems.



**Oreco Systems**  
Incorporated

814 AIRWAY AVENUE

SUTHERLIN, OREGON

97479-9012

TELEPHONE:



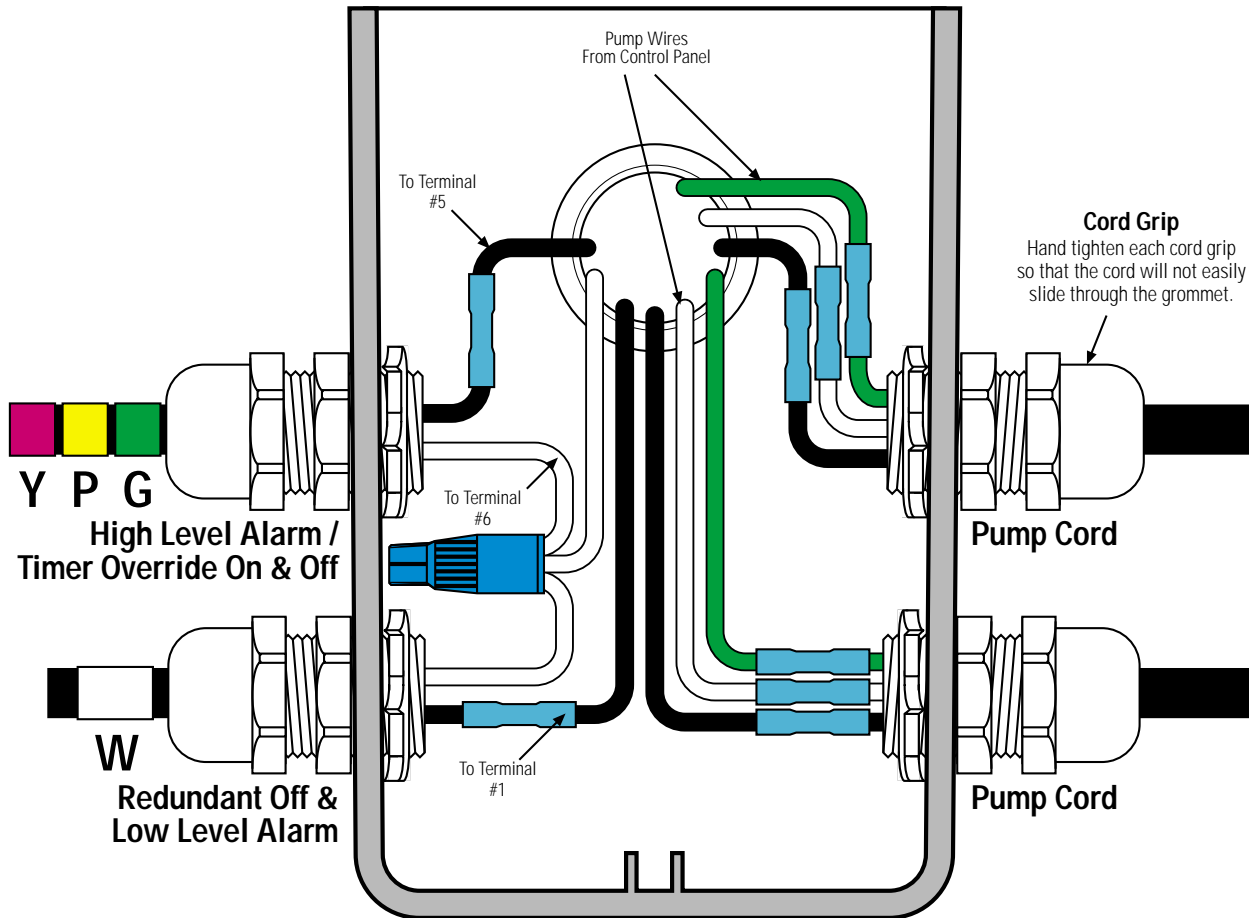

(541) 459-4449

FACSIMILE:

(541) 459-2884

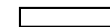

## Key

-  Black Wire
-  White Wire
-  Green Wire
-  Waterproof Wire Nut
-  Heat Shrink & Butt Connector \*

\* Refer to drawing EIN-SB-SB-1 for splicing instructions.

## Float Tag Colors

- Y** - Yellow
- P** - Purple
- B** - Blue
- G** - Green
- R** - Red
- O** - Orange
- E** - Grey
- W** - White

Note: Multi-function floats will have more than one marker

**Attention:** Failure to follow splicing instructions will void warranty

Control Panel Series

**MVP-DAX**

Float Function Color Code

**(YPG)W**

Splice Box Model

**SB4**

Drawing No.

**EDW-SB-DAX-105**

EDW-SB-DAX-105  
Rev 1.0 © 12/04/98

# MVP-DAX PT RO Operation



**Oreco Systems®**  
Incorporated

814 AIRWAY AVENUE  
SUTHERLIN, OREGON  
97479-9012

TELEPHONE:  
(541) 459-4449

FACSIMILE:  
(541) 459-2884

Oreco's Most Versatile Panel (MVP) line of control panels includes an easy-to-use programmable logic unit that incorporates many timing and logic functions. The units have built in screens which show the time and date, digital input status, digital output status, analog input status (3 screens), analog output status, memory flag status and an ESC + Cursor key status. (The analog input status, analog output status, memory flag status and ESC + Cursor key status screens are not used in this application.) Additionally, the following system data screens have been included in your panel:

System Data Screens:	Description:
1. Pump 1 CT & ETM	Pump 1 cycle counter at top of screen and pump run time in minutes beneath
2. Pump 2 CT & ETM	Pump 2 cycle counter at top of screen and pump run time in minutes beneath
3. OVR 1 CT & OVR 2 CT	Pump 1 override counter at top and pump 2 override counter beneath
4. High Lvl CT & Low Level CT	High level alarm counter at top of screen and low level counter beneath
5. Power Faults & Operating Hr	Power fault counter at top of screen and operating hours beneath

To move between screens, use the four arrow keys. The screens are accessed as shown below:

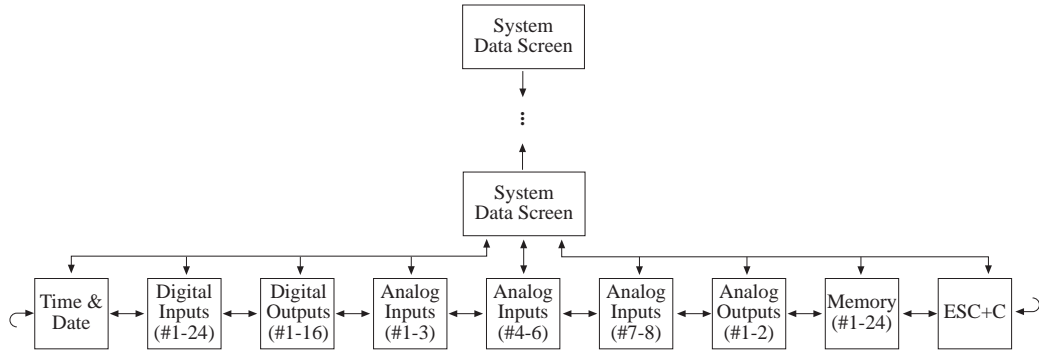

**Digital Input and Digital Output Screens:** The unit will activate various inputs and outputs as it operates (please refer to the Liquid Crystal Display screens shown below). Knowing what conditions cause the inputs and outputs to activate can be a helpful installation and troubleshooting tool. The following inputs and outputs have been used with your control panel:

**Input Functions:**

1. Redundant Off & Low Level Alarm Float
2. Timer On & Off Float
3. Override Timer On & Off Float
4. Lag Enable Float
5. High Level Alarm Float
6. Push To Silence

**Activation Conditions:**

- Float in up position
- Float in up position
- Float in up position
- Float in up position
- Float in up position
- Pushbutton is pressed

**Output Functions:**

1. Pump #1
2. Pump #2
3. Level Alarm Light
4. Audible Alarm

**Activation Conditions:**

- Pump #1 is activated
- Pump #2 is activated
- Level Alarm Light is activated
- Audible Alarm is activated

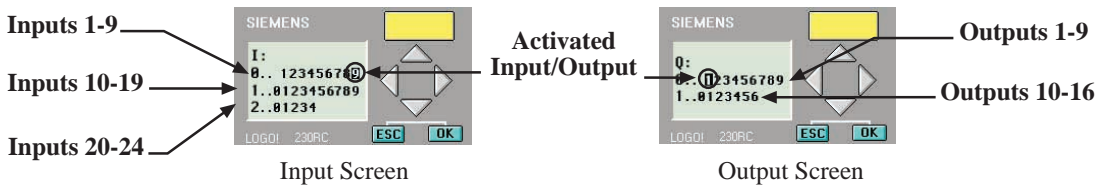

Your control panel can perform the float functions listed below. Depending on the number of floats for your application, some functions may be omitted or combined.

**High Level Alarm:** This float activates the alarm light (steady) and audible alarm when lifted for longer than the high level alarm delay. The audible alarm may be silenced by pressing the illuminated PUSH TO SILENCE button on the front of the control panel. The alarm light (steady) will remain on until the float is lowered, and the audible alarm will reactivate in 12 hours if condition is not corrected.

**Lag Pump Enable:** This float will activate both pumps when the timer function enters the on cycle. Both pumps will continue to run together until the lag pump enable float lowers.

**Override Timer On & Off:** This float activates the override timer function when lifted for more than two seconds. This timer function controls the pump cycles during high flow conditions. The override timer function will remain active until at least the set minimum number of override cycles have been completed and the float has lowered. When the override timer function has been completed, normal timer operation will resume.

**Timer On & Off:** This float activates the timer function when lifted. The timer will be activated while the float is up and will be deactivated 30 seconds after the float is lowered. This timer function controls the pump cycles during normal flow conditions. Note: The timer will start with its off cycle.

**Redundant Off & Low Level Alarm:** This float turns off the pumps when lowered for more than two seconds. This float is a secondary off float which will operate if the Timer On & Off float fails. Pumping will be disabled in both the automatic and manual modes. This float also activates the alarm light (flashing) and audible alarm. The audible alarm may be silenced by pressing the illuminated PUSH TO SILENCE button on the front of the control panel. The alarm light will remain flashing until the float is lifted, and the audible alarm will reactivate in 12 hours if condition is not corrected.

This panel supports four different modes of operation relating to the pump alternation which are based on selected parameter settings. See the setting page for this panel for information on how to adjust these parameters.

**Alternating (default):** Parameters “Pmp1Lead” and “Pmp2Lead” set to “Off”  
The lead and lag pumps will alternate and for each cycle. This mode provides equal wear on each pump and is recommended for most applications.

**Pump 1 Lead:** Parameter “Pmp1Lead” set to “On” and parameter “Pmp2Lead” set to “Off”  
The lead pump is locked to pump #1 and the lag pump is locked to pump #2. No alternation will occur. Pump #1 will be the primary pump for the system. Pump #2 will only be used during high flow conditions.

**Pump 2 Lead:** Parameter “Pmp1Lead” set to “Off” and parameter “Pmp2Lead” set to “On”  
The lead pump is locked to pump #2 and the lag pump is locked to pump #1. No alternation will occur. Pump #2 will be the primary pump for the system. Pump #1 will only be used during high flow conditions.

**Both Pumps:** Parameters “Pmp1Lead” and “Pmp2Lead” set to “On”  
Both pumps will run together for every cycle.

# MVP-DAX PT RO Setting



Oreco Systems®  
Incorporated

814 AIRWAY AVENUE  
SUTHERLIN, OREGON  
97479-9012

TELEPHONE:  
(541) 459-4449

FACSIMILE:  
(541) 459-2884

Oreco’s Most Versatile Panel (MVP) line of control panels includes an easy-to-use programmable logic unit that incorporates many timing and logic functions. The unit has been programmed at the factory for the control functions required. The unit includes adjustable operational parameters and viewable monitoring information. Some operational parameters may need changing for your particular application.

The unit uses block names to identify the various parameters (please refer to the Liquid Crystal Display screen shown in Step #3). The following block types have been used with your control panel:

Block Names	Description	Factory Default	Time Range	Block Type
HLA Dly	High Level Alarm Delay	5 seconds	MM:SS	Timer
Off Time	Timer Off Time	60 minutes	MM:SS	Timer
On Time	Timer On Time	40 seconds	MM:SS	Timer
OVR Off	Override Timer Off Time	30 minutes	MM:SS	Timer
OVR On	Override Timer On Time	40 seconds	MM:SS	Timer
MinOCycl	Minimum Override Cycles	3 cycles		Counter
Pmp1Lead	Pump 1 Lead Select	Off		Softkey
Pmp2Lead	Pump 2 Lead Select	Off		Softkey

Timer blocks have three timebase units that can be used; s = seconds, m = minutes, h = hours. If an **h** appears after the timer setting then the time will be HH:MM (e.g. 01:55h = 1 hour and 55 minutes). If an **m** appears after the timer setting then the time will be MM:SS (e.g. 05:00m = 5 minutes and 0 seconds). If an **s** appears after the timer setting then the time will be SS.ss (e.g. 25:13s = 25.13 seconds).

All adjustable parameters DO NOT use the same type of blocks, check the block types above to determine which steps apply to your application.

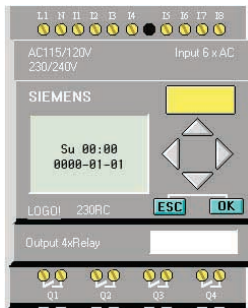

## Changing Adjustable Parameter Blocks:

Step 1: Press **▼** repeatedly until the display does not change. To begin the configuration process, press the “ESC” key.

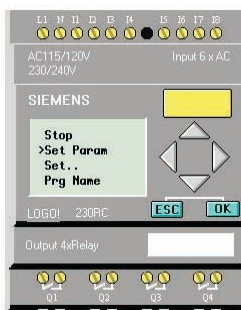

Step 2: Press **▼** on the unit to select “Set Param.” Then press the “OK” key.

**Warning: Do not select “Stop.” Doing so may erase the panel programming, which can not be restored without the use of an EEPROM card, which is not included with the panel. If this is selected by accident, a confirmation screen will come up. Select “No” and press the “OK” key immediately.**

## Changing Adjustable Parameter Timer Blocks:

Step 3: Press **▲** or **▼** to view the parameter values. In this example, “Off Time” is being viewed.



Step 4: The first line indicates the set value for the parameter. In this example, the set time is 1 hour and 55 minutes, “T=01:55h.” To change the set value for the parameter, press the “OK” key.

The second line indicates, in real time, how much time has elapsed for the cycle that is currently in process. The current value of the parameter is 45 minutes, “Ta=00:45.”



Step 5: The cursor will appear in the set value. To select the digit to be changed, press **◀** or **▶**. To change the value of a digit, press **▲** or **▼**. In this example, the set value has been changed from 1 hour and 55 minutes to 58 minutes and 15 seconds. (The timebase can be changed from hours = h to minutes = m or seconds = s by moving the cursor to the far right and pressing **▲** or **▼**).

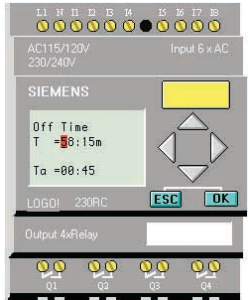

Step 6: When the desired time value has been entered, press the “OK” key. The new time value will now be in effect.

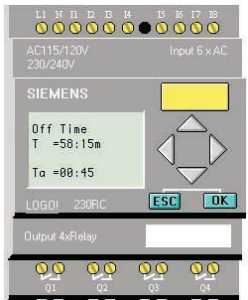

Step 7: To exit parameter mode, press the “ESC” key twice.

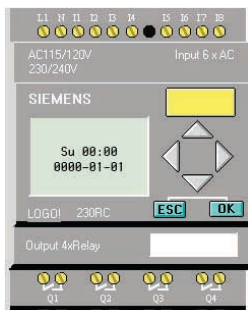



## Changing Adjustable Parameter Counter Blocks:

Step 3: Press **▲** or **▼** to view the parameter values. In this example, “**MinOCycl**” is being viewed.



Step 4: The first line indicates the on threshold for the parameter. In this example, the “**MinOCycl**” is 3, “**On = 3.**” To change the set value for the parameter, press the “**OK**” key.

The second line indicates the off threshold. This value must be set to zero, “**Off = 0.**”

The third line indicates, in real time, how many counts have occurred for this process. The current value of the parameter is 2, “**Cnt = 2.**”



Step 5: The cursor will appear in the set value. To select the digit to be changed, press **◀** or **▶**. To change the value of a digit, press **▲** or **▼**. In this example, the set value has been changed from 3 to 2.



Step 6: When the desired counter value has been entered, press the “**OK**” key. The new value will now be in effect.

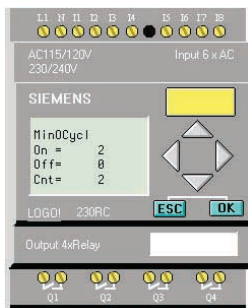

Step 7: To exit parameter mode, press the “**ESC**” key twice.

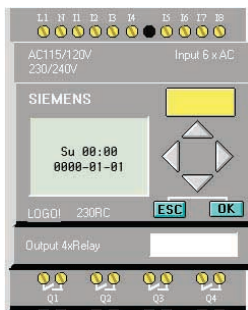

## Changing Adjustable Parameter Softkey Blocks:

Step 3: Press **▲** or **▼** to view the parameter values. In this example, **“Pmp1Lead”** is being viewed.

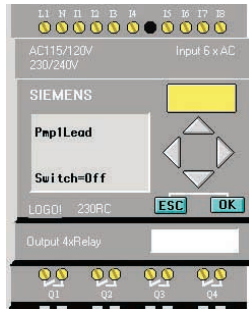

Step 4: The bottom line indicates the current state of the softkey switch. In this example, the softkey is set to **“Off”**. To change the set value for the parameter, press the **“OK”** key.



Step 5: The cursor will appear on the switch parameter. To change the value of the softkey switch, press **▲** or **▼**. In this example, the set value has been changed from **“Off”** to **“On.”**

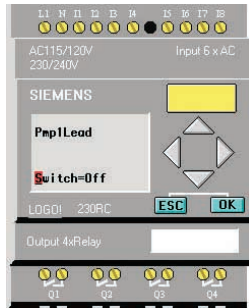

Step 6: When the desired value has been entered, press the **“OK”** key. The new value will now be in effect.

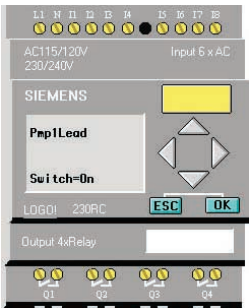

Step 7: To exit parameter mode, press the **“ESC”** key twice.

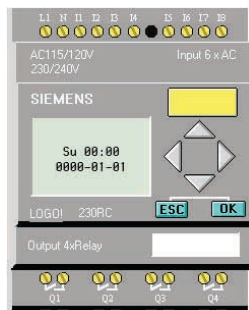

## MVP-DAX PT RO Reference Chart

Program Code: DA103-50

### Input Functions:

1. RO & Low Level Alarm Float
2. Timer On & Off Float
3. Override Timer On & Off Float
4. Lag Enable Float
5. High Level Alarm Float
6. Push to Silence

### Conditions for activation:

- Float in up position
- Float in up position
- Float in up position
- Float in up position
- Float in up position
- Pushbutton is pressed

### Output Functions:

1. Pump #1
2. Pump #2
3. Level Light
4. Audible Alarm

### Condition for activation:

- Pump #1 is activated
- Pump #2 is activated
- Alarm Light is activated
- Audible Alarm is activated

### Built In Screens:

Built in screens are time & date, digital inputs, digital outputs, analog inputs, analog outputs, memory flag, and ESC+cursor key status. To view these screens, press the down arrow repeatedly until a built in screen appears, then use the left and right arrow keys to change between screens.

### System Data Screens:

To change between screens, press the up and down arrow keys. The following screens have been used with your panel.

### Screens:

1. Pump 1 Cycl CT & ETM
2. Pump 2 Cycl CT & ETM
3. OVR 1 CT & OVR 2 CT
4. High Lvl CT & Low Level CT
5. Power Faults & Operating Hr

### Description:

- Pump #1 cycle counter on top and pump run time in minutes below
- Pump #2 cycle counter on top and pump run time in minutes below
- Pump #1 override counter on top and pump #2 below
- High level alarm counter on top and low level alarm counter below
- Power fault counter on top and operating hours below

### Selecting Blocks for Viewing or Adjusting:

To begin to adjust parameters, press 'ESC'.

### Block Names:

- |          |                         |       |
|----------|-------------------------|-------|
| HLA Dly  | High Level Alarm Delay  | MM:SS |
| Off Time | Timer Off Time          | MM:SS |
| On Time  | Timer On Time           | MM:SS |
| OVR Off  | Override Timer Off Time | MM:SS |
| OVR On   | Override Timer On Time  | MM:SS |
| MinOCycl | Minimum Override Cycles |       |
| Pmp1Lead | Pump 1 Lead Select      |       |
| Pmp2Lead | Pump 2 Lead Select      |       |

### Time Range:

EIN-CP-REF-2  
Rev 6.0 © 08/11/05

## MVP-DAX PT RO Reference Chart

Program Code: DA103-50

### Input Functions:

1. RO & Low Level Alarm Float
2. Timer On & Off Float
3. Override Timer On & Off Float
4. Lag Enable Float
5. High Level Alarm Float
6. Push to Silence

### Conditions for activation:

- Float in up position
- Float in up position
- Float in up position
- Float in up position
- Float in up position
- Pushbutton is pressed

### Output Functions:

1. Pump #1
2. Pump #2
3. Level Light
4. Audible Alarm

### Condition for activation:

- Pump #1 is activated
- Pump #2 is activated
- Alarm Light is activated
- Audible Alarm is activated

### Built In Screens:

Built in screens are time & date, digital inputs, digital outputs, analog inputs, analog outputs, memory flag, and ESC+cursor key status. To view these screens, press the down arrow repeatedly until a built in screen appears, then use the left and right arrow keys to change between screens.

### System Data Screens:

To change between screens, press the up and down arrow keys. The following screens have been used with your panel.

### Screens:

1. Pump 1 Cycl CT & ETM
2. Pump 2 Cycl CT & ETM
3. OVR 1 CT & OVR 2 CT
4. High Lvl CT & Low Level CT
5. Power Faults & Operating Hr

### Description:

- Pump #1 cycle counter on top and pump run time in minutes below
- Pump #2 cycle counter on top and pump run time in minutes below
- Pump #1 override counter on top and pump #2 below
- High level alarm counter on top and low level alarm counter below
- Power fault counter on top and operating hours below

### Selecting Blocks for Viewing or Adjusting:

To begin to adjust parameters, press 'ESC'.

### Block Names:

- |          |                         |       |
|----------|-------------------------|-------|
| HLA Dly  | High Level Alarm Delay  | MM:SS |
| Off Time | Timer Off Time          | MM:SS |
| On Time  | Timer On Time           | MM:SS |
| OVR Off  | Override Timer Off Time | MM:SS |
| OVR On   | Override Timer On Time  | MM:SS |
| MinOCycl | Minimum Override Cycles |       |
| Pmp1Lead | Pump 1 Lead Select      |       |
| Pmp2Lead | Pump 2 Lead Select      |       |

### Time Range:

EIN-CP-REF-2  
Rev 6.0 © 08/11/05

## MVP-DAX PT RO Reference Chart

Program Code: DA103-50

### Input Functions:

1. RO & Low Level Alarm Float
2. Timer On & Off Float
3. Override Timer On & Off Float
4. Lag Enable Float
5. High Level Alarm Float
6. Push to Silence

### Conditions for activation:

- Float in up position
- Float in up position
- Float in up position
- Float in up position
- Float in up position
- Pushbutton is pressed

### Condition for activation:

- Pump #1 is activated
- Pump #2 is activated
- Alarm Light is activated
- Audible Alarm is activated

### Output Functions:

1. Pump #1
2. Pump #2
3. Level Light
4. Audible Alarm

### Built In Screens:

Built in screens are time & date, digital inputs, digital outputs, analog inputs, analog outputs, memory flag, and ESC+cursor key status. To view these screens, press the down arrow repeatedly until a built in screen appears, then use the left and right arrow keys to change between screens.

### System Data Screens:

To change between screens, press the up and down arrow keys. The following screens have been used with your panel.

### Screens:

1. Pump 1 Cycl CT & ETM
2. Pump 2 Cycl CT & ETM
3. OVR 1 CT & OVR 2 CT
4. High Lvl CT & Low Level CT
5. Power Faults & Operating Hr

### Description:

- Pump #1 cycle counter on top and pump run time in minutes below
- Pump #2 cycle counter on top and pump run time in minutes below
- Pump #1 override counter on top and pump #2 below
- High level alarm counter on top and low level alarm counter below
- Power fault counter on top and operating hours below

### Selecting Blocks for Viewing or Adjusting:

To begin to adjust parameters, press 'ESC'.

### Block Names:

- |          |                         |       |
|----------|-------------------------|-------|
| HLA Dly  | High Level Alarm Delay  | MM:SS |
| Off Time | Timer Off Time          | MM:SS |
| On Time  | Timer On Time           | MM:SS |
| OVR Off  | Override Timer Off Time | MM:SS |
| OVR On   | Override Timer On Time  | MM:SS |
| MinOCycl | Minimum Override Cycles |       |
| Pmp1Lead | Pump 1 Lead Select      |       |
| Pmp2Lead | Pump 2 Lead Select      |       |

### Time Range:

- MM:SS
- MM:SS
- MM:SS
- MM:SS
- MM:SS

EIN-CP-REF-2  
Rev 6.0 © 08/11/05